

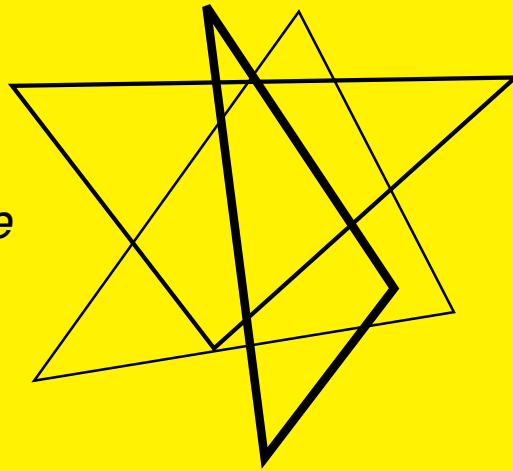

\$1

# Trigonometry Tables and Handy References for Engineers

*No matter what angle  
you figure...*



*Carr Lane is your best answer  
for jig-and-fixture components!*

AUTHORIZED DISTRIBUTOR

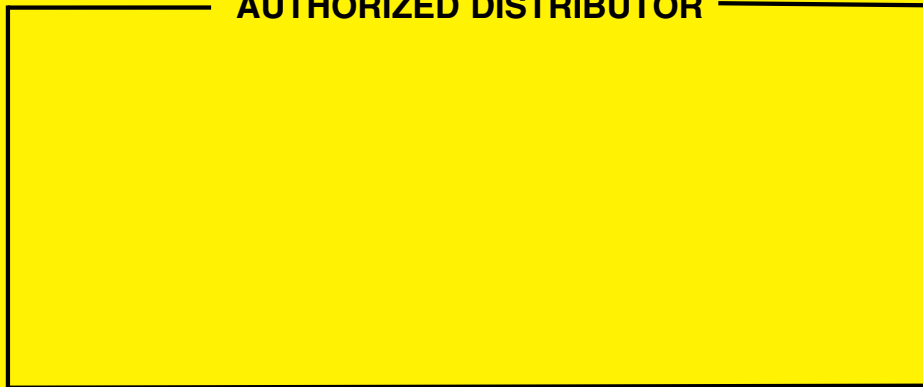

**M A N U F A C T U R I N G C O .**

4200 Carr Lane Ct., P.O. Box 191970 • St. Louis, Missouri 63119-7970 USA  
Phone: 314/647-6200 • Fax: 314/647-5736 • Web Site: [www.carrlane.com](http://www.carrlane.com)

# ***Toggle Clamps With Safety Locks***

Avoid accidents by using Carr Lane's toggle clamps, available in the following varieties, many with optional safety locks:

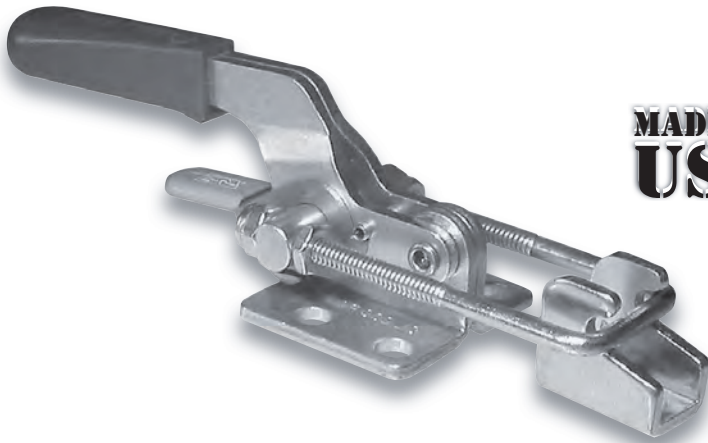

**MADE IN  
USA**

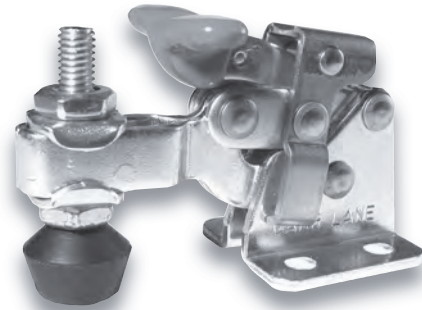

- Horizontal Handle
- Vertical Handle
- Push/Pull
- Latch Action
- Air-Powered
- Toggle Edge Clamps



***Carr Lane***<sup>®</sup>

MANUFACTURING CO.  
4200 Carr Lane Ct., P.O. Box 191970 • St. Louis, Missouri 63119-7970 USA  
Phone: 314/647-6200 • Fax: 314/647-5736 • Web Site: [www.carrlane.com](http://www.carrlane.com)

**Visit our web site:  
[carrlane.com](http://carrlane.com)**



**ISO 9001-2008  
CERTIFIED**

# TABLE OF CONTENTS

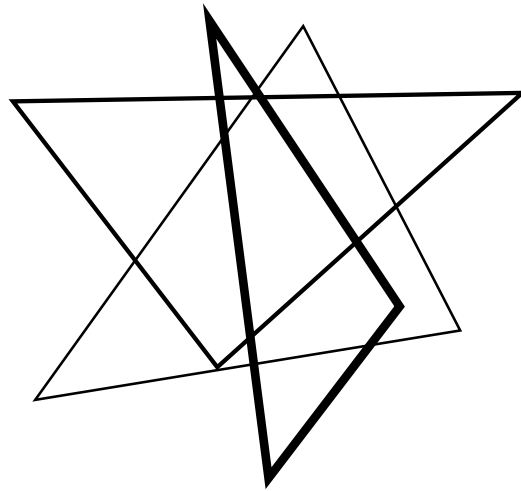

Thread Sizes and Tap Drills.....	2
Standard Drill Sizes .....	4
Counterbored Holes for Cap Screws.....	6
Geometric Dimensioning and Tolerancing .....	7
Surface Finishes .....	12
Clamping Force of Standard Clamp Straps.....	13
Basic Numbering System for Steels .....	14
Machinability Comparison of Various Metals.....	15
Hardness Conversions and Tensile Strength.....	16
Metric Prefixes .....	23
Conversion Factors for Units of Measure .....	24
Trigonometry Calculations .....	45
Trigonometry Tables.....	50



**M A N U F A C T U R I N G C O .**  
4200 Carr Lane Ct., P.O. Box 191970 • St. Louis, Missouri 63119-7970 USA  
Phone: 314/647-6200 • Fax: 314/647-5736 • Web Site: [www.carrlane.com](http://www.carrlane.com)

# USA THREADS

Thread Size*	Basic Major Diameter	Tap Drill Size**
#0-80	.0600	3/64
<b>#2-56</b>	.0860	#50
#2-64	.0860	#50
<b>#4-40</b>	.1120	#43
#4-48	.1120	#42
<b>#5-40</b>	.1250	#38
#5-44	.1250	#37
<b>#6-32</b>	.1380	#36
#6-40	.1380	#33
<b>#8-32</b>	.1640	#29
#8-36	.1640	#29
<b>#10-24</b>	.1900	#25
#10-32	.1900	#21
<b>1/4-20</b>	.2500	#7
1/4-28	.2500	#3
<b>5/16-18</b>	.3125	F
5/16-24	.3125	I
<b>3/8-16</b>	.3750	5/16
3/8-24	.3750	Q
<b>7/16-14</b>	.4375	U
7/16-20	.4375	25/64
<b>1/2-13</b>	.5000	27/64
1/2-20	.5000	29/64
<b>9/16-12</b>	.5625	31/64
9/16-18	.5625	33/64
<b>5/8-11</b>	.6250	17/32
5/8-18	.6250	37/64
<b>3/4-10</b>	.7500	21/32
3/4-16	.7500	11/16
<b>7/8-9</b>	.8750	49/64
7/8-14	.8750	13/16
<b>1-8</b>	1.0000	7/8
1-14	1.0000	15/16
<b>1-1/8-7</b>	1.1250	63/64
1-1/8-12	1.1250	1-3/64

# METRIC THREADS

Thread Size*	Basic Major Diameter	Tap Drill Size**
<b>M1.6</b> x0.35	.0630	1.25mm or #55
<b>M2</b> x0.4	.0787	1.60mm or #52
<b>M2.5</b> x0.45	.0984	2.05mm or #46
<b>M3</b> x0.5	.1181	2.50mm or #39
<b>M3.5</b> x0.6	.1378	2.90mm or #32
<b>M4</b> x0.7	.1575	3.30mm or #30
<b>M5</b> x0.8	.1969	4.20mm or #19
<b>M6</b> x1	.2362	5.00mm or #8
<b>M8</b> x1.25	.3150	6.80mm or H
M8x1	.3150	7.00mm or J
<b>M10</b> x1.5	.3937	8.50mm or R
M10x1.25	.3937	8.80mm or 11/32
<b>M12</b> x1.75	.4724	10.20mm or 13/32
M12x1.25	.4724	10.80mm or 27/64
<b>M14</b> x2	.5512	12.00mm or 15/32
M14x1.5	.5512	12.50mm or 1/2
<b>M16</b> x2	.6299	14.00mm or 35/64
M16x1.5	.6299	14.50mm or 37/64
<b>M18</b> x2.5	.7087	15.50mm or 39/64
M18x1.5	.7087	16.50mm or 21/32
<b>M20</b> x2.5	.7874	17.50mm or 11/16
M20x1.5	.7874	18.50mm or 47/64
<b>M22</b> x2.5	.8661	19.50mm or 49/64
M22x1.5	.8661	20.50mm or 13/16
<b>M24</b> x3	.9449	21.00mm or 53/64
M24x2	.9449	22.00mm or 7/8
<b>M27</b> x3	1.0630	24.00mm or 15/16
M27x2	1.0630	25.00mm or 1

\* Coarse series shown in bold. Pitch callout not required on metric coarse series.

\*\* Closest size for 75% theoretical thread.

# USA DRILL SIZES

Drill Decimal	Drill Decimal	Drill Decimal	Drill Decimal
80	.0135	40	.0980
79	.0145	39	.0995
1/64	.0156	38	.1015
78	.0160	37	.1040
77	.0180	36	.1065
76	.0200	7/64	.1094
75	.0210	35	.1100
74	.0225	34	.1110
73	.0240	33	.1130
72	.0250	32	.1160
71	.0260	31	.1200
70	.0280	<b>1/8</b>	<b>.1250</b>
69	.0292	30	.1285
68	.0310	29	.1360
1/32	.0312	28	.1405
67	.0320	9/64	.1406
66	.0330	27	.1440
65	.0350	26	.1470
64	.0360	25	.1495
63	.0370	24	.1520
62	.0380	23	.1540
61	.0390	5/32	.1562
60	.0400	22	.1570
59	.0410	21	.1590
58	.0420	20	.1610
57	.0430	19	.1660
56	.0465	18	.1695
3/64	.0469	11/64	.1719
55	.0520	17	.1730
54	.0550	16	.1770
53	.0595	15	.1800
<b>1/16</b>	<b>.0625</b>	14	.1820
52	.0635	13	.1850
51	.0670	<b>3/16</b>	<b>.1875</b>
50	.0700	12	.1890
49	.0730	11	.1910
48	.0760	10	.1935
5/64	.0781	9	.1960
47	.0785	8	.1990
46	.0810	7	.2010
45	.0820	13/64	.2031
44	.0860	6	.2040
43	.0890	5	.2055
42	.0935	4	.2090
3/32	.0938	3	.2130
41	.0960	7/32	.2188
		2	.2210
		1	.2280
		A	.2340
		15/64	.2344
		B	.2380
		C	.2420
		D	.2460
		E	.2500
		<b>1/4</b>	<b>.2500</b>
		F	.2570
		G	.2610
		17/64	.2656
		H	.2660
		I	.2720
		J	.2770
		K	.2810
		9/32	.2812
		L	.2900
		M	.2950
		19/64	.2969
		N	.3020
		<b>5/16</b>	<b>.3125</b>
		O	.3160
		P	.3230
		21/64	.3281
		Q	.3320
		R	.3390
		11/32	.3438
		S	.3480
		T	.3580
		23/64	.3594
		U	.3680
		<b>3/8</b>	<b>.3750</b>
		V	.3770
		W	.3860
		25/64	.3906
		X	.3970
		Y	.4040
		13/32	.4062
		Z	.4130
		27/64	.4219
		<b>7/16</b>	<b>.4375</b>
		29/64	.4531
		15/32	.4688
		31/64	.4844
		<b>1/2</b>	<b>.5000</b>
		33/64	.5156
		17/32	.5312
		35/64	.5469
		<b>9/16</b>	<b>.5625</b>
		37/64	.5781
		19/32	.5938
		39/64	.6094
		<b>5/8</b>	<b>.6250</b>
		41/64	.6406
		21/32	.6562
		43/64	.6719
		<b>11/16</b>	<b>.6875</b>
		45/64	.7031
		23/32	.7188
		47/64	.7344
		<b>3/4</b>	<b>.7500</b>
		49/64	.7656
		25/32	.7812
		51/64	.7969
		<b>13/16</b>	<b>.8125</b>
		53/64	.8281
		27/32	.8438
		55/64	.8594
		<b>7/8</b>	<b>.8750</b>
		57/64	.8906
		29/32	.9062
		59/64	.9219
		<b>15/16</b>	<b>.9375</b>
		61/64	.9531
		31/32	.9688
		63/64	.9844
		<b>1</b>	<b>1.0000</b>
			+64th increments up to 1-7/8"
			+32nd increments up to 2-1/4"
			+16th increments up to 4-1/4"

# METRIC DRILL SIZES

Drill	Decimal	Drill	Decimal	Drill	Decimal	Drill	Decimal
.35mm	.0138	2.50mm	.0984	6.20mm	.2441	<b>10.00mm</b>	<b>.3937</b>
.38mm	.0150	2.55mm	.1004	6.25mm	.2461	10.20mm	.4016
.40mm	.0157	2.60mm	.1024	6.30mm	.2480	10.50mm	.4134
.42mm	.0165	2.65mm	.1043	6.40mm	.2520	10.80mm	.4252
.45mm	.0177	2.70mm	.1063	6.50mm	.2559	<b>11.00mm</b>	<b>.4331</b>
.48mm	.0189	2.75mm	.1083	6.60mm	.2598	11.20mm	.4409
.50mm	.0197	2.80mm	.1102	6.70mm	.2638	11.50mm	.4528
.55mm	.0217	2.90mm	.1142	6.75mm	.2657	11.80mm	.4646
.60mm	.0236	<b>3.00mm</b>	<b>.1181</b>	6.80mm	.2677	<b>12.00mm</b>	<b>.4724</b>
.65mm	.0256	3.10mm	.1220	6.90mm	.2717	12.20mm	.4803
.70mm	.0276	3.20mm	.1260	<b>7.00mm</b>	<b>.2756</b>	12.50mm	.4921
.75mm	.0295	3.25mm	.1280	7.10mm	.2795	<b>13.00mm</b>	<b>.5118</b>
.80mm	.0315	3.30mm	.1299	7.20mm	.2835	13.50mm	.5315
.85mm	.0335	3.40mm	.1339	7.25mm	.2854	<b>14.00mm</b>	<b>.5512</b>
.90mm	.0354	3.50mm	.1378	7.30mm	.2874	14.50mm	.5709
.95mm	.0374	3.60mm	.1417	7.40mm	.2913	<b>15.00mm</b>	<b>.5906</b>
<b>1.00mm</b>	<b>.0394</b>	3.70mm	.1457	7.50mm	.2953	15.50mm	.6102
1.05mm	.0413	3.75mm	.1476	7.60mm	.2992	<b>16.00mm</b>	<b>.6299</b>
1.10mm	.0433	3.80mm	.1496	7.70mm	.3031	16.50mm	.6496
1.15mm	.0453	3.90mm	.1535	7.75mm	.3051	<b>17.00mm</b>	<b>.6693</b>
1.20mm	.0472	<b>4.00mm</b>	<b>.1575</b>	7.80mm	.3071	17.50mm	.6890
1.25mm	.0492	4.10mm	.1614	7.90mm	.3110	<b>18.00mm</b>	<b>.7087</b>
1.30mm	.0512	4.20mm	.1654	<b>8.00mm</b>	<b>.3150</b>	18.50mm	.7283
1.35mm	.0531	4.25mm	.1673	8.10mm	.3189	<b>19.00mm</b>	<b>.7480</b>
1.40mm	.0551	4.30mm	.1693	8.20mm	.3228	19.50mm	.7677
1.45mm	.0571	4.40mm	.1732	8.25mm	.3248	<b>20.00mm</b>	<b>.7874</b>
1.50mm	.0591	4.50mm	.1772	8.30mm	.3268	20.50mm	.8071
1.55mm	.0610	4.60mm	.1811	8.40mm	.3307	<b>21.00mm</b>	<b>.8268</b>
1.60mm	.0630	4.70mm	.1850	8.50mm	.3346	21.50mm	.8465
1.65mm	.0650	4.75mm	.1870	8.60mm	.3386	<b>22.00mm</b>	<b>.8661</b>
1.70mm	.0669	4.80mm	.1890	8.70mm	.3425	22.50mm	.8858
1.75mm	.0689	4.90mm	.1929	8.75mm	.3445	<b>23.00mm</b>	<b>.9055</b>
1.80mm	.0709	<b>5.00mm</b>	<b>.1969</b>	8.80mm	.3465	23.50mm	.9252
1.85mm	.0728	5.10mm	.2008	8.90mm	.3504	<b>24.00mm</b>	<b>.9449</b>
1.90mm	.0748	5.20mm	.2047	<b>9.00mm</b>	<b>.3543</b>	24.50mm	.9646
1.95mm	.0768	5.25mm	.2067	9.10mm	.3583	<b>25.00mm</b>	<b>.9843</b>
<b>2.00mm</b>	<b>.0787</b>	5.30mm	.2087	9.20mm	.3622		
2.05mm	.0807	5.40mm	.2126	9.25mm	.3642	+1.00mm	
2.10mm	.0827	5.50mm	.2165	9.30mm	.3661	increments	
2.15mm	.0846	5.60mm	.2205	9.40mm	.3701	up to 48mm	
2.20mm	.0866	5.70mm	.2244	9.50mm	.3740		
2.25mm	.0886	5.75mm	.2264	9.60mm	.3780	+5.00mm	
2.30mm	.0906	5.80mm	.2283	9.70mm	.3819	increments	
2.35mm	.0925	5.90mm	.2323	9.75mm	.3839	from 50mm	
2.40mm	.0945	<b>6.00mm</b>	<b>.2362</b>	9.80mm	.3858	up to 105mm	
2.45mm	.0965	6.10mm	.2402	9.90mm	.3898		

# COUNTERBORED HOLES

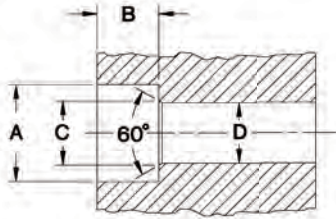

## USA SOCKET-HEAD CAP SCREWS

SCREW DIA	A COUNTERBORE DIA	B COUNTERBORE DEPTH	C COUNTERSINK DIA	D CLEARANCE DIA	
				NORMAL FIT	CLOSE FIT
#0	1/8	.060	.074	#49	#51
#2	3/16	.086	.102	#36	3/32
#4	7/32	.112	.130	#29	1/8
#5	1/4	.125	.145	#23	9/64
#6	9/32	.138	.158	#18	#23
#8	5/16	.164	.188	#10	#15
#10	3/8	.190	.218	#2	#5
1/4	7/16	.250	.278	9/32	17/64
5/16	17/32	.312	.346	11/32	21/64
3/8	5/8	.375	.415	13/32	25/64
7/16	23/32	.438	.483	15/32	29/64
1/2	13/16	.500	.552	17/32	33/64
5/8	1	.625	.689	21/32	41/64
3/4	1-3/16	.750	.828	25/32	49/64
7/8	1-3/8	.875	.963	29/32	57/64
1	1-5/8	1.000	1.100	1-1/32	1-1/64
1-1/4	2	1.250	1.370	1-5/16	1-9/32
1-1/2	2-3/8	1.500	1.640	1-9/16	1-17/32
1-3/4	2-3/4	1.750	1.910	1-13/16	1-25/32
2	3-1/8	2.000	2.180	2-1/16	2-1/32

## METRIC SOCKET-HEAD CAP SCREWS

M1.6	3.50mm	1.6mm	2.0mm	1.95mm	1.80mm
M2	4.40mm	2mm	2.6mm	2.40mm	2.20mm
M2.5	5.40mm	2.5mm	3.1mm	3.00mm	2.70mm
M3	6.50mm	3mm	3.6mm	3.70mm	3.40mm
M4	8.25mm	4mm	4.7mm	4.80mm	4.40mm
M5	9.75mm	5mm	5.7mm	5.80mm	5.40mm
M6	11.20mm	6mm	6.8mm	6.80mm	6.40mm
M8	14.50mm	8mm	9.2mm	8.80mm	8.40mm
M10	17.50mm	10mm	11.2mm	10.80mm	10.50mm
M12	19.50mm	12mm	14.2mm	13.00mm	12.50mm
M14	22.50mm	14mm	16.2mm	15.00mm	14.50mm
M16	25.50mm	16mm	18.2mm	17.00mm	16.50mm
M20	31.50mm	20mm	22.4mm	21.00mm	20.50mm
M24	37.50mm	24mm	26.4mm	25.00mm	24.50mm
M30	47.50mm	30mm	33.4mm	31.50mm	31.00mm
M36	56.50mm	36mm	39.4mm	37.50mm	37.00mm
M42	66.00mm	42mm	45.6mm	44.00mm	43.00mm
M48	75.00mm	48mm	52.6mm	50.00mm	49.00mm



# GEOMETRIC SYMBOLS AND DEFINITIONS

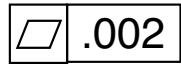

Individual Features

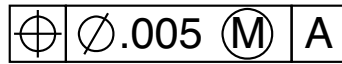

Related Features

## Feature-Control Frame

A specification box that shows a particular geometric characteristic (flatness, straightness, etc.) applied to a part feature and states the allowable tolerance. The feature's tolerance may be individual, or related to one or more datums. Any datum references and tolerance modifiers are also shown.



### Datum Feature

A flag which designates a physical feature of the part to be used as a reference to measure geometric characteristics of other part features.

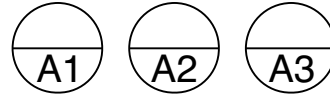

### Datum Targets

Callouts occasionally needed to designate specific points, lines, or areas on an actual part to be used to establish a theoretical datum feature.

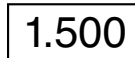

### Basic Dimension

A box around any drawing dimension makes it a "basic" dimension, a theoretically exact value used as a reference for measuring geometric characteristics and tolerances of other part features.



### Cylindrical Tolerance Zone

This symbol, commonly used to indicate a diameter dimension, also specifies a cylindrically shaped tolerance zone in a feature-control frame.



### Maximum Material Condition

Abbreviation: MMC. A tolerance modifier that applies the stated tight tolerance zone only while the part theoretically contains the maximum amount of material permitted within its dimensional limits (e.g. minimum hole diameters and maximum shaft diameters), allowing more variation under normal conditions.



### Least Material Condition

Abbreviation: LMC. A tolerance modifier that applies the stated tight tolerance zone only while the part theoretically contains the minimum amount of material permitted within its dimensional limits (e.g. maximum hole diameters and minimum shaft diameters), allowing more variation under normal conditions.



### Regardless of Feature Size

Abbreviation: RFS. A tolerance modifier that applies the stated tight tolerance zone under all size conditions. RFS is generally assumed if neither MMC nor LMC are stated.

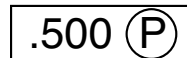

### Projected Tolerance Zone

An additional specification box attached underneath a feature-control frame. It extends the feature's tolerance zone beyond the part's surface by the stated distance, ensuring perpendicularity for proper alignment of mating parts.

# GEOMETRIC CHARACTERISTICS

## Flatness

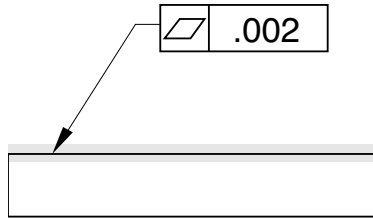

All points on the indicated surface must lie in a single plane, within the specified tolerance zone.

## Straightness

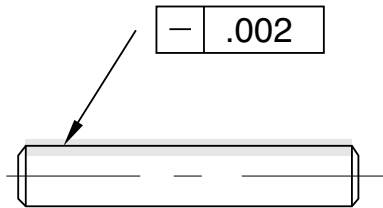

All points on the indicated surface or axis must lie in a straight line in the direction shown, within the specified tolerance zone.

## Circularity (Roundness)

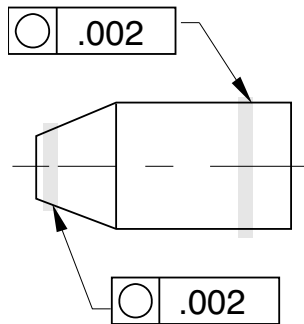

If the indicated surface were sliced by any plane perpendicular to its axis, the resulting outline must be a perfect circle, within the specified tolerance zone.

## Cylindricity

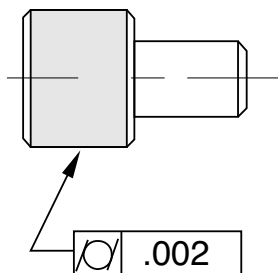

All points on the indicated surface must lie in a perfect cylinder around a center axis, within the specified tolerance zone.

# GEOMETRIC CHARACTERISTICS

## Linear Profile

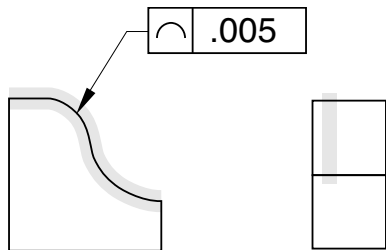

All points on any full slice of the indicated surface must lie on its theoretical two-dimensional profile, as defined by basic dimensions, within the specified tolerance zone. The profile may or may not be oriented with respect to datums.

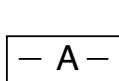
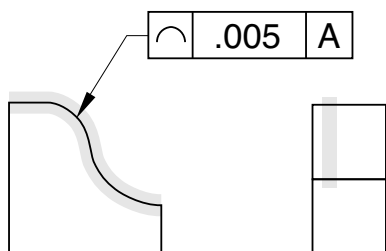

## Surface Profile

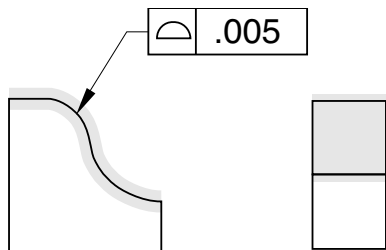

All points on the indicated surface must lie on its theoretical three-dimensional profile, as defined by basic dimensions, within the specified tolerance zone. The profile may or may not be oriented with respect to datums.

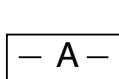
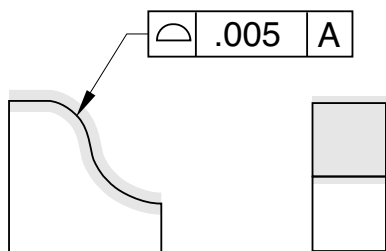

# GEOMETRIC CHARACTERISTICS

## $\perp$ Perpendicularity (Squareness)

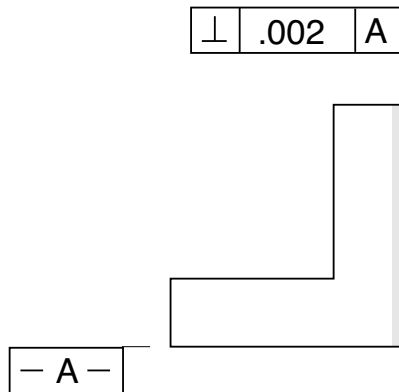

All points on the indicated surface, axis, or line must lie in a single plane exactly  $90^\circ$  from the designated datum plane or axis, within the specified tolerance zone.

## $\sphericalangle$ Angularity

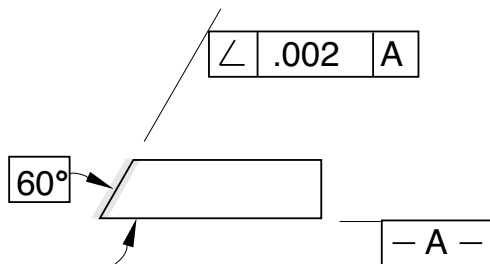

All points on the indicated surface or axis must lie in a single plane at exactly the specified angle from the designated datum plane or axis, within the specified tolerance zone.

## // Parallelism

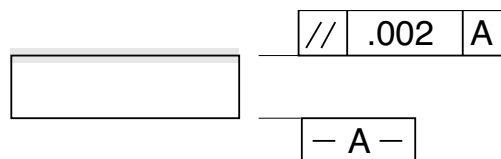

All points on the indicated surface or axis must lie in a single plane parallel to the designated datum plane or axis, within the specified tolerance zone.

# GEOMETRIC CHARACTERISTICS

## Circular Runout

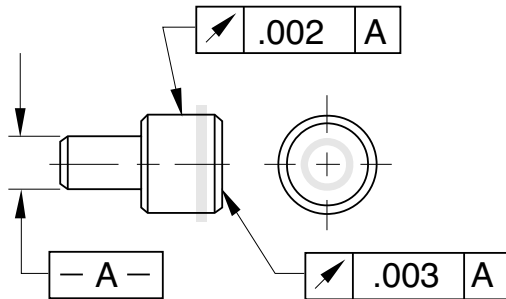

Each circular element of the indicated surface is allowed to deviate only the specified amount from its theoretical form and orientation during 360° rotation about the designated datum axis.

## Total Runout

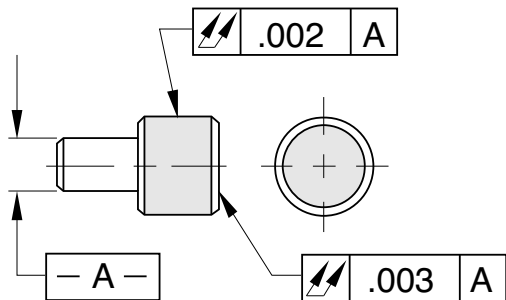

The entire indicated surface is allowed to deviate only the specified amount from its theoretical form and orientation during 360° rotation about the designated datum axis.

## Concentricity

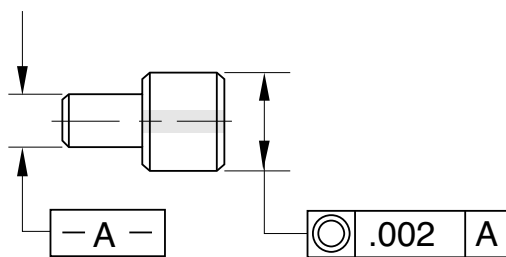

If the indicated surface were sliced by any plane perpendicular to the designated datum axis, every slice's center of area must lie on the datum axis, within the specified cylindrical tolerance zone (controls rotational balance).

## Position (Replaces Symmetry)

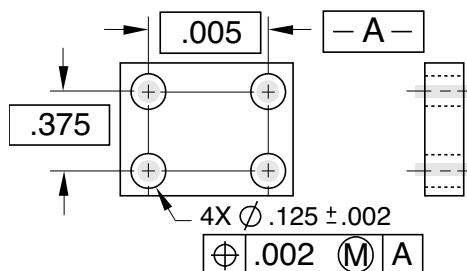

The indicated feature's axis must be located within the specified tolerance zone from its true theoretical position, correctly oriented relative to the designated datum plane or axis.

# TYPICAL SURFACE FINISHES PRODUCED BY VARIOUS PRODUCTION METHODS

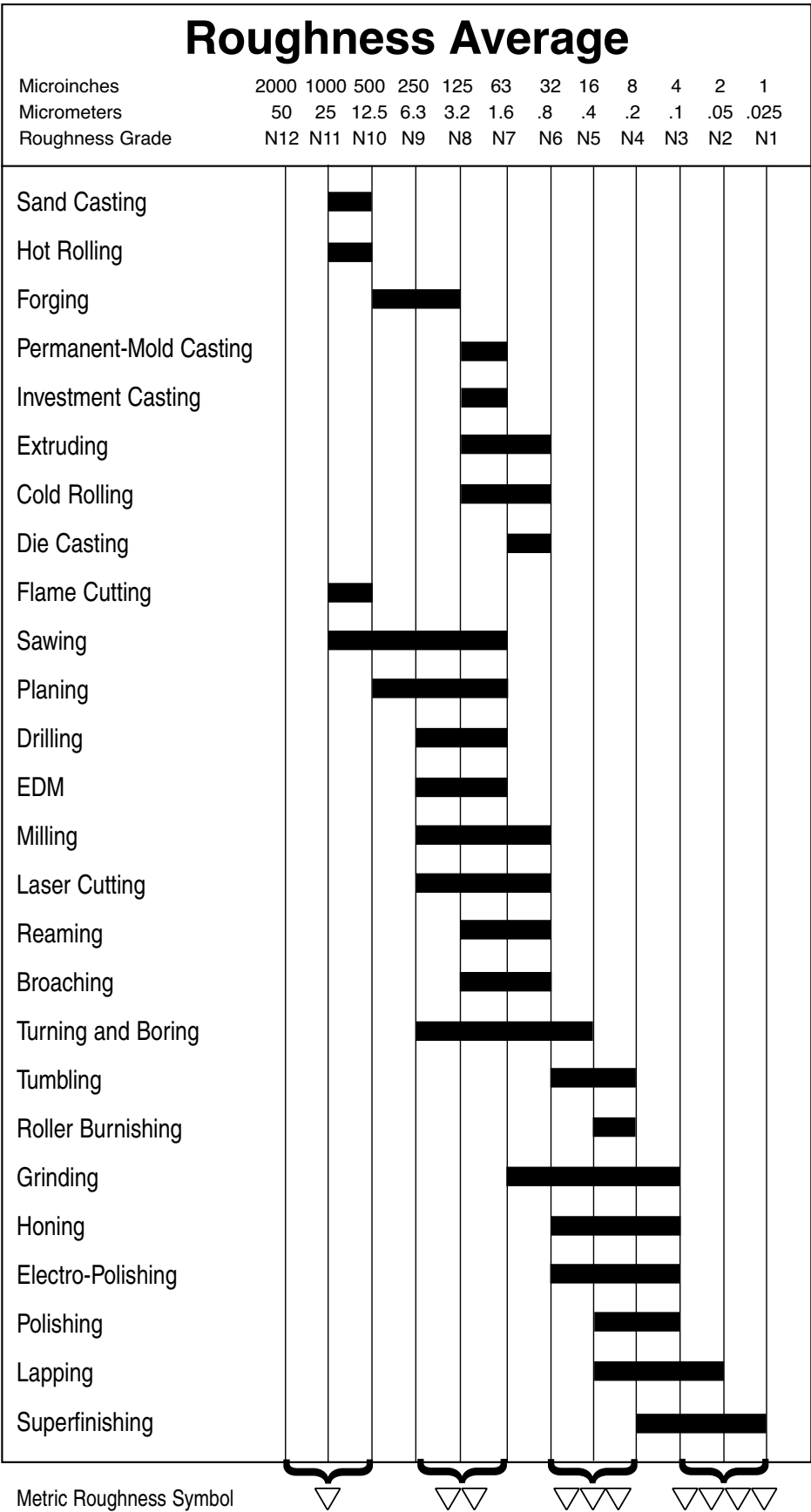

# CLAMPING FORCE OF STANDARD CLAMP STRAPS

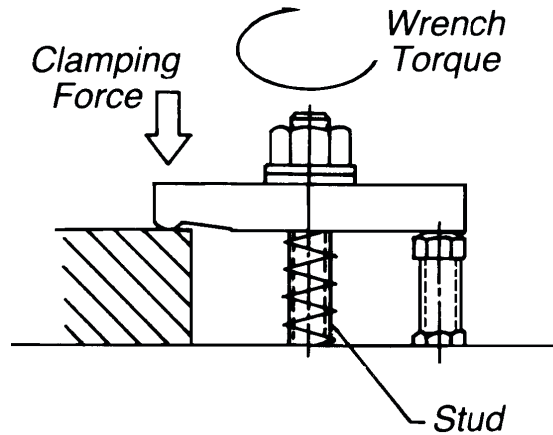

## USA

Stud Size	Recommended Torque* (ft.-lbs.)	Clamping Force (lbs.)	Tensile Force in Stud (lbs.)
#10-32	2	300	600
1/4-20	4	500	1000
5/16-18	9	900	1800
3/8-16	16	1300	2600
1/2-13	38	2300	4600
5/8-11	77	3700	7400
3/4-10	138	5500	11000
7/8-9	222	7600	15200
1-8	333	10000	20000

## METRIC

M6	4	500	1000
M8	9	900	1800
M10	20	1500	3000
M12	35	2200	4400
M16	84	4000	8000
M20	165	6300	12600
M24	283	9000	18000

\*Clean, dry clamping stud torqued to approximately 33% of its 100,000 psi yield strength (2:1 lever ratio).

# AISI/SAE NUMBERING SYSTEM FOR CARBON AND ALLOY STEELS

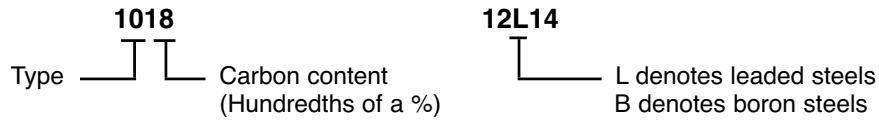

Carbon Steels	10XX	Plain Carbon, Mn 1.00% max
	11XX	Resulfurized Free Machining
	12XX	Resulfurized/Rephosphorized Free Machining
	15XX	Plain Carbon, Mn 1.00-1.65%
Manganese Steel	13XX	Mn 1.75%
Nickel Steels	23XX	Ni 3.50%
	25XX	Ni 5.00%
Nickel-Chromium Steels	31XX	Ni 1.25%, Cr .65-.80%
	32XX	Ni 1.75%, Cr 1.07%
	33XX	Ni 3.50%, Cr 1.50-1.57%
	34XX	Ni 3.00%, Cr .77%
Molybdenum Steels	40XX	Mo .20-.25%
	44XX	Mo .40-.52%
Chromium-Molybdenum Steels	41XX	Cr .50-.95%, Mo .12-.30%
Nickel-Chromium-Molybdenum Steels	43XX	Ni 1.82%, Cr .50-.80%, Mo .25%
	47XX	Ni 1.05%, Cr .45%, Mo .20-.35%
Nickel-Molybdenum Steels	46XX	Ni .85-1.82%, Mo .20-.25%
	48XX	Ni 3.50%, Mo .25%
Chromium Steels	50XX	Cr .27-.65%
	51XX	Cr .80-1.05%
	50XXX	Cr .50%, C 1.00% min
	51XXX	Cr 1.02%, C 1.00% min
	52XXX	Cr 1.45%, C 1.00% min
Chromium-Vanadium Steels	61XX	Cr .60-.95%, V .10-.15%
Tungsten-Chromium Steels	72XX	W 1.75%, Cr .75%
Nickel-Chromium-Molybdenum Steels	81XX	Ni .30%, Cr .40%, Mo .12%
	86XX	Ni .55%, Cr .50%, Mo .20%
	87XX	Ni .55%, Cr .50%, Mo .25%
	88XX	Ni .55%, Cr .50%, Mo .35%
Silicon-Manganese Steels	92XX	Si 1.40-2.00%, Mn .65-.85%, Cr 0-.65%
Nickel-Chromium-Molybdenum Steels	93XX	Ni 3.25%, Cr 1.20%, Mo .12%
	94XX	Ni .45%, Cr .40%, Mo .12%
	97XX	Ni .55%, Cr .20%, Mo .20%
	98XX	Ni 1.00%, Cr .80%, Mo .25%



# MACHINABILITY COMPARISON\*

## Carbon Steels:

1015.....	72%	1137 .....	72%
1018.....	78%	1141 .....	70%
1020.....	72%	1141 Annealed .....	81%
1022.....	78%	1144 .....	76%
1030.....	70%	1144 Annealed .....	85%
1040.....	64%	1144 Stressproof.....	83%
1042.....	64%	1212 .....	100%
1050.....	54%	1213 .....	136%
1095.....	42%	12L14 .....	170%
1117 .....	91%	1215 .....	136%

## Alloy Steels:

2355 Annealed .....	70%	4620 .....	66%
4130 Annealed .....	72%	4820 Annealed .....	49%
4140 Annealed .....	66%	52100 Annealed .....	40%
4142 Annealed .....	66%	6150 Annealed .....	60%
41L42 Annealed .....	77%	8620 .....	66%
4150 Annealed .....	60%	86L20 .....	77%
4340 Annealed .....	57%	9310 Annealed .....	51%

## Stainless Steels and Super Alloys:

302 Annealed .....	45%	420 Annealed .....	45%
303 Annealed .....	78%	430 Annealed .....	54%
304 Annealed .....	45%	431 Annealed .....	45%
316 Annealed .....	45%	440A.....	45%
321 Annealed .....	36%	15-5PH Condition A .....	48%
347 Annealed .....	36%	17-4PH Condition A .....	48%
410 Annealed .....	54%	A286 Aged .....	33%
416 Annealed .....	110%	Hastelloy X.....	19%

## Tool Steels:

A-2.....	42%	M-2.....	39%
A-6.....	33%	O-1 .....	42%
D-2 .....	27%	O-2 .....	42%
D-3 .....	27%		

## Gray Cast Iron:

ASTM Class 20 Annealed	73%	ASTM Class 40 .....	48%
ASTM Class 25 .....	55%	ASTM Class 45 .....	36%
ASTM Class 30 .....	48%	ASTM Class 50 .....	36%
ASTM Class 35 .....	48%		

## Nodular Iron:

60-40-18 Annealed .....	61%	80-55-06.....	39%
65-45-12 Annealed .....	61%		

## Aluminum and Magnesium Alloys:

Aluminum, Cold Drawn..	360%	Magnesium, Cold Drawn .....	480%
Aluminum, Cast .....	450%	Magnesium, Cast.....	480%
Aluminum, Die Cast.....	76%		

\* Relative machining speed based on 1212 as 100%. All figures are based on cold-drawn bars in as-drawn condition, except where noted.

# APPROXIMATE HARDNESS CONVERSIONS FOR STEEL

Rockwell		Rockwell Superficial				Brinell		Vickers	Shore	Approximate Tensile Strength (psi)				
A	B	C	D	E	F	15-N 15 kg Brale	30-N 30 kg Brale	45-N 45 kg Brale	30-T 30 kg 16" Ball	3000 kg 10mm Ball Steel*	500 kg 10mm Ball Steel	136° Diamond Pyramid	Sclero- scope	
86.5	—	70	78.5	—	—	94.0	86.0	77.6	—	—	—	1076	101	—
86.0	—	69	77.7	—	—	93.5	85.0	76.5	—	—	—	1044	99	—
85.6	—	68	76.9	—	—	93.2	84.4	75.4	—	—	—	940	97	—
85.0	—	67	76.1	—	—	92.9	83.6	74.2	—	—	—	900	95	—
84.5	—	66	75.4	—	—	92.5	82.8	73.2	—	—	—	865	92	—
83.9	—	65	74.5	—	—	92.2	81.9	72.0	—	—	—	832	91	—
83.4	—	64	73.8	—	—	91.8	81.1	71.0	—	—	—	800	88	—
82.8	—	63	73.0	—	—	91.4	80.1	69.9	—	—	—	772	87	—
82.3	—	62	72.2	—	—	91.1	79.3	68.8	—	—	—	746	85	—
81.8	—	61	71.5	—	—	90.7	78.4	67.7	—	—	—	720	83	—
81.2	—	60	70.7	—	—	90.2	77.5	66.6	—	—	—	697	81	320,000
80.7	—	59	69.9	—	—	89.8	76.6	65.5	—	—	—	674	80	310,000
80.1	—	58	69.2	—	—	89.3	75.7	64.3	—	—	—	653	78	300,000
79.6	—	57	68.5	—	—	88.9	74.8	63.2	—	—	—	633	76	290,000
79.0	—	56	67.7	—	—	88.3	73.9	62.0	—	—	—	613	75	282,000
78.5	120	55	66.9	—	—	87.9	73.0	60.9	—	—	—	595	74	274,000
78.0	120	54	66.1	—	—	87.4	72.0	59.8	—	—	—	577	72	266,000
77.4	119	53	65.4	—	—	86.9	71.2	58.6	—	—	—	560	71	257,000
76.8	119	52	64.6	—	—	86.4	70.2	57.4	—	—	—	544	69	245,000
76.3	118	51	63.8	—	—	85.9	69.4	56.1	—	—	—	528	68	239,000
75.9	117	50	63.1	—	—	85.5	68.5	55.0	—	—	—	513	67	233,000
75.2	117	49	62.1	—	—	85.0	67.6	53.8	—	—	—	498	66	227,000
74.7	116	48	61.4	—	—	84.5	66.7	52.5	—	—	—	484	64	221,000
74.1	116	47	60.8	—	—	83.9	65.8	51.4	—	—	—	471	63	217,000
73.6	115	46	60.0	—	—	83.5	64.8	50.3	—	—	—	458	62	212,000

\*Brinell hardness values above 500 are listed for a 10mm carbide ball instead of a steel ball.

# APPROXIMATE HARDNESS CONVERSIONS FOR STEEL

Rockwell		Rockwell Superficial					Brinell		Vickers	Shore	Approximate Tensile Strength (psi)				
		B	C	D	E	F	15-N	30-N				45-N	30-T	3000 kg 10mm Ball Steel	500 kg 10mm Ball Steel
A	60 kg Brale	100 kg 1/16" Ball	150 kg Brale	100 kg Brale	100 kg 1/8" Ball	60 kg 1/16" Ball	15 kg Brale	30 kg Brale	45 kg Brale	30 kg 1/16" Ball	3000 kg 10mm Ball Steel	500 kg 10mm Ball Steel	136° Diamond Pyramid	Sclero-scope	
73.1	115	45	59.2	—	—	—	83.0	64.0	49.0	—	421	—	446	60	206,000
72.5	114	44	58.5	—	—	—	82.5	63.1	47.8	—	409	—	434	58	200,000
72.0	113	43	57.7	—	—	—	82.0	62.2	46.7	—	400	—	423	57	196,000
71.5	113	42	56.9	—	—	—	81.5	61.3	45.5	—	390	—	412	56	191,000
70.9	112	41	56.2	—	—	—	80.9	60.4	44.3	—	381	—	402	55	187,000
70.4	112	40	55.4	—	—	—	80.4	59.5	43.1	—	371	—	392	54	182,000
69.9	111	39	54.6	—	—	—	79.9	58.6	41.9	—	362	—	382	52	177,000
69.4	110	38	53.8	—	—	—	79.4	57.7	40.8	—	353	—	372	51	173,000
68.9	110	37	53.1	—	—	—	78.8	56.8	39.6	—	344	—	363	50	169,000
68.4	109	36	52.3	—	—	—	78.3	55.9	38.4	—	336	—	354	49	165,000
67.9	109	35	51.5	—	—	—	77.7	55.0	37.2	—	327	—	345	48	160,000
67.4	108	34	50.8	—	—	—	77.2	54.2	36.1	—	319	—	336	47	156,000
66.8	108	33	50.0	—	—	—	76.6	53.3	34.9	—	311	—	327	46	152,000
66.3	107	32	49.2	—	—	—	76.1	52.1	33.7	—	301	—	318	44	147,000
65.8	106	31	48.4	—	—	—	75.6	51.3	32.5	—	294	—	310	43	144,000
65.3	105	30	47.7	—	—	—	75.0	50.4	31.3	—	286	—	302	42	140,000
64.7	104	29	47.0	—	—	—	74.5	49.5	30.1	—	279	—	294	41	137,000
64.3	104	28	46.1	—	—	—	73.9	48.6	28.9	—	271	—	286	41	133,000
63.8	103	27	45.2	—	—	—	73.3	47.7	27.8	—	264	—	279	40	129,000
63.3	103	26	44.6	—	—	—	72.8	46.8	26.7	—	258	—	272	39	126,000
62.8	102	25	43.8	—	—	—	72.2	45.9	25.5	—	253	—	266	38	124,000
62.4	101	24	43.1	—	—	—	71.6	45.0	24.3	—	247	—	260	37	121,000
62.0	100	23	42.1	—	—	—	71.0	44.0	23.1	82.0	240	201	254	36	118,000
61.5	99	22	41.6	—	—	—	70.5	43.2	22.0	81.5	234	195	248	35	115,000
61.0	98	21	40.9	—	—	—	69.9	42.3	20.7	81.0	228	189	243	35	112,000

# APPROXIMATE HARDNESS CONVERSIONS FOR STEEL

Rockwell		Rockwell Superficial				Rockwell		Brinell		Vickers	Shore	Approximate Tensile Strength (psi)		
		A	B	C	D	E	F	15-N	30-N				45-N	30-T
60 kg Brale	100 kg 1/16" Ball	150 kg Brale	100 kg Brale	100 kg 1/8" Ball	60 kg 1/16" Ball	15 kg Brale	30 kg Brale	45 kg Brale	30 kg 1/16" Ball	3000 kg 10mm Ball Steel	500 kg 10mm Ball Steel	136° Diamond Pyramid	Sclero-scope	Approximate Tensile Strength (psi)
60.5	97	20	40.1	—	—	69.4	41.5	19.6	80.5	222	184	238	34	109,000
59.0	96	18	—	—	—	—	—	—	80.0	216	179	230	33	106,000
58.0	95	16	—	—	—	—	—	—	79.0	210	175	222	32	103,000
57.5	94	15	—	—	—	—	—	—	78.5	205	171	213	31	100,000
57.0	93	13	—	—	—	—	—	—	78.0	200	167	208	30	98,000
56.5	92	12	—	—	—	—	—	—	77.5	195	163	204	29	96,000
56.0	91	10	—	—	—	—	—	—	77.0	190	160	196	28	93,000
55.5	90	9	—	—	—	—	—	—	76.0	185	157	192	27	91,000
55.0	89	8	—	—	—	—	—	—	75.5	180	154	188	26	88,000
54.0	88	7	—	—	—	—	—	—	75.0	176	151	184	26	86,000
53.5	87	6	—	—	—	—	—	—	74.5	172	148	180	26	84,000
53.0	86	5	—	—	—	—	—	—	74.0	169	145	176	25	83,000
52.5	85	4	—	—	—	—	—	—	73.5	165	142	173	25	81,000
52.0	84	3	—	—	—	—	—	—	73.0	162	140	170	25	79,000
51.0	83	2	—	—	—	—	—	—	72.0	159	137	166	24	78,000
50.5	82	1	—	—	—	—	—	—	71.5	156	135	163	24	76,000
50.0	81	0	—	—	—	—	—	—	71.0	153	133	160	24	75,000
49.5	80	—	—	—	—	—	—	—	70.0	150	130	—	—	73,000
49.0	79	—	—	—	—	—	—	—	69.5	147	128	—	—	—
48.5	78	—	—	—	—	—	—	—	69.0	144	126	—	—	—
48.0	77	—	—	—	—	—	—	—	68.0	141	124	—	—	—
47.0	76	—	—	—	—	—	—	—	67.5	139	122	—	—	—
46.5	75	—	—	—	99.5	—	—	—	67.0	137	120	—	—	—
46.0	74	—	—	—	99.0	—	—	—	66.0	135	118	—	—	—
45.5	73	—	—	—	98.5	—	—	—	65.5	132	116	—	—	—

# APPROXIMATE HARDNESS CONVERSIONS FOR STEEL

Rockwell		Rockwell Superficial			Brinell		Vickers	Shore	Approximate Tensile Strength (psi)					
A	B	C	D	E	F	15-N	30-N	45-N	30-T	3000 kg 10mm Ball Steel	500 kg 10mm Ball Steel	136° Diamond Pyramid	Sclero-scope	
60 kg Brale	100 kg 1/16" Ball	150 kg Brale	100 kg Brale	100 kg 1/8" Ball	60 kg 1/16" Ball	15 kg Brale	30 kg Brale	45 kg Brale	30 kg 1/16" Ball	3000 kg 10mm Ball Steel	500 kg 10mm Ball Steel			
45.0	72	—	—	—	98.0	—	—	—	65.0	130	114	—	—	—
44.5	71	—	—	100.0	97.5	—	—	—	64.2	127	112	—	—	—
44.0	70	—	—	99.5	97.0	—	—	—	63.5	125	110	—	—	—
43.5	69	—	—	99.0	96.0	—	—	—	62.8	123	109	—	—	—
43.0	68	—	—	98.0	95.5	—	—	—	62.0	121	107	—	—	—
42.5	67	—	—	97.5	95.0	—	—	—	61.4	119	106	—	—	—
42.0	66	—	—	97.0	94.5	—	—	—	60.5	117	104	—	—	—
41.8	65	—	—	96.0	94.0	—	—	—	60.1	116	102	—	—	—
41.5	64	—	—	95.5	93.5	—	—	—	59.5	114	101	—	—	—
41.0	63	—	—	95.0	93.0	—	—	—	58.7	112	99	—	—	—
40.5	62	—	—	94.5	92.0	—	—	—	58.0	110	98	—	—	—
40.0	61	—	—	93.5	91.5	—	—	—	57.3	108	96	—	—	—
39.5	60	—	—	93.0	91.0	—	—	—	56.5	107	95	—	—	—
39.0	59	—	—	92.5	90.5	—	—	—	55.9	106	94	—	—	—
38.5	58	—	—	92.0	90.0	—	—	—	55.0	104	92	—	—	—
38.0	57	—	—	91.0	89.5	—	—	—	54.6	102	91	—	—	—
37.8	56	—	—	90.5	89.0	—	—	—	54.0	101	90	—	—	—
37.5	55	—	—	90.0	88.0	—	—	—	53.2	99	89	—	—	—
37.0	54	—	—	89.5	87.5	—	—	—	52.5	—	87	—	—	—
36.5	53	—	—	89.0	87.0	—	—	—	51.8	—	86	—	—	—
36.0	52	—	—	88.0	86.5	—	—	—	51.0	—	85	—	—	—
35.5	51	—	—	87.5	86.0	—	—	—	50.4	—	84	—	—	—
35.0	50	—	—	87.0	85.5	—	—	—	49.5	—	83	—	—	—
34.8	49	—	—	86.5	85.0	—	—	—	49.1	—	82	—	—	—
34.5	48	—	—	85.5	84.5	—	—	—	48.5	—	81	—	—	—

# APPROXIMATE HARDNESS CONVERSIONS FOR STEEL

Rockwell		Rockwell Superficial			Brinell		Vickers	Shore	Approximate Tensile Strength (psi)					
A	B	C	D	E	F	15-N	30-N	45-N	30-T	3000 kg 10mm Ball Steel	500 kg 10mm Ball Steel	136° Diamond Pyramid	Sclero-scope	
60 kg Brale	100 kg 1/16" Ball	150 kg Brale	100 kg Brale	100 kg 1/8" Ball	60 kg 1/16" Ball	15 kg Brale	30 kg Brale	45 kg Brale	30 kg 1/16" Ball					
34.0	47	—	—	85.0	84.0	—	—	—	47.7	—	80	—	—	—
33.5	46	—	—	84.5	83.0	—	—	—	47.0	—	79	—	—	—
33.0	45	—	—	84.0	82.5	—	—	—	46.2	—	79	—	—	—
32.5	44	—	—	83.5	82.0	—	—	—	45.5	—	78	—	—	—
32.0	43	—	—	82.5	81.5	—	—	—	44.8	—	77	—	—	—
31.5	42	—	—	82.0	81.0	—	—	—	44.0	—	76	—	—	—
31.0	41	—	—	81.5	80.5	—	—	—	43.4	—	75	—	—	—
30.8	40	—	—	81.0	79.5	—	—	—	43.0	—	74	—	—	—
30.5	39	—	—	80.0	79.0	—	—	—	42.1	—	74	—	—	—
30.0	38	—	—	79.5	78.5	—	—	—	41.5	—	73	—	—	—
29.5	37	—	—	79.0	78.0	—	—	—	40.7	—	72	—	—	—
29.0	36	—	—	78.5	77.5	—	—	—	40.0	—	71	—	—	—
28.5	35	—	—	78.0	77.0	—	—	—	39.3	—	71	—	—	—
28.0	34	—	—	77.0	76.5	—	—	—	38.5	—	70	—	—	—
27.8	33	—	—	76.5	75.5	—	—	—	37.9	—	69	—	—	—
27.5	32	—	—	76.0	75.0	—	—	—	37.5	—	68	—	—	—
27.0	31	—	—	75.5	74.5	—	—	—	36.6	—	68	—	—	—
26.5	30	—	—	75.0	74.0	—	—	—	36.0	—	67	—	—	—
26.0	29	—	—	74.0	73.5	—	—	—	35.2	—	66	—	—	—
25.5	28	—	—	73.5	73.0	—	—	—	34.5	—	66	—	—	—
25.0	27	—	—	73.0	72.5	—	—	—	33.8	—	65	—	—	—
24.5	26	—	—	72.5	72.0	—	—	—	33.1	—	65	—	—	—
24.2	25	—	—	72.0	71.0	—	—	—	32.4	—	64	—	—	—
24.0	24	—	—	71.0	70.5	—	—	—	32.0	—	64	—	—	—
23.5	23	—	—	70.5	70.0	—	—	—	31.1	—	63	—	—	—

# APPROXIMATE HARDNESS CONVERSIONS FOR STEEL

Rockwell		Rockwell Superficial			Brinell		Vickers	Shore	Approximate Tensile Strength (psi)					
<b>A</b> 60 kg Brale	<b>B</b> 100 kg 1/16" Ball	<b>C</b> 150 kg Brale	<b>D</b> 100 kg Brale	<b>E</b> 100 kg 1/8" Ball	<b>F</b> 60 kg 1/16" Ball	<b>15-N</b> 15 kg Brale	<b>30-N</b> 30 kg Brale	<b>45-N</b> 45 kg Brale	<b>30-T</b> 30 kg 1/16" Ball	3000 kg 10mm Ball Steel	500 kg 10mm Ball Steel	136° Diamond Pyramid	Sclero- scope	
23.0	22	—	—	70.0	69.5	—	—	—	30.4	—	63	—	—	—
22.5	21	—	—	69.5	69.0	—	—	—	29.7	—	62	—	—	—
22.0	20	—	—	68.5	68.5	—	—	—	29.0	—	62	—	—	—
21.5	19	—	—	68.0	68.0	—	—	—	28.1	—	61	—	—	—
21.2	18	—	—	67.5	67.0	—	—	—	27.4	—	61	—	—	—
21.0	17	—	—	67.0	66.5	—	—	—	26.7	—	60	—	—	—
20.5	16	—	—	66.5	66.0	—	—	—	26.0	—	60	—	—	—
20.0	15	—	—	65.5	65.5	—	—	—	25.3	—	59	—	—	—
—	14	—	—	65.0	65.0	—	—	—	24.6	—	59	—	—	—
—	13	—	—	64.5	64.5	—	—	—	23.9	—	58	—	—	—
—	12	—	—	64.0	64.0	—	—	—	23.5	—	58	—	—	—
—	11	—	—	63.5	63.5	—	—	—	22.6	—	57	—	—	—
—	10	—	—	62.5	63.0	—	—	—	21.9	—	57	—	—	—
—	9	—	—	62.0	62.0	—	—	—	21.2	—	56	—	—	—
—	8	—	—	61.5	61.5	—	—	—	20.5	—	56	—	—	—
—	7	—	—	61.0	61.0	—	—	—	19.8	—	56	—	—	—
—	6	—	—	60.5	60.5	—	—	—	19.1	—	55	—	—	—
—	5	—	—	60.0	60.0	—	—	—	18.4	—	55	—	—	—
—	4	—	—	59.0	59.5	—	—	—	18.0	—	55	—	—	—
—	3	—	—	58.5	59.0	—	—	—	17.1	—	54	—	—	—
—	2	—	—	58.0	58.0	—	—	—	16.4	—	54	—	—	—
—	1	—	—	57.5	57.5	—	—	—	15.7	—	53	—	—	—
—	0	—	—	57.0	57.0	—	—	—	15.0	—	53	—	—	—

Hardness values in italics are beyond the normal range of that scale and are listed for reference only.



## **SINGLE-ACTING BALL LOCK PINS**

Precision ground locating pin. Press button to insert or remove. Positive locking until released by pressing button. Available in four handle styles. Two locking balls standard, with four balls available for greater pull-out strength. 3/16 to 1" diameters standard. Available in alloy or stainless steel.

## **DOUBLE-ACTING BALL LOCK PINS**

Similar to a single-acting pin, except you release by pulling or pushing the handle. Positive locking. Choice of three handle styles. Available with drive-out option (internal spindle extends beyond the shank end). This feature lets you remove a pin under shear loading by tapping the shank end with a hammer.

## **ADJUSTABLE BALL LOCK PINS**

Single-acting ball lock pin with adjustable grip length (1/2-inch range). Adjust grip by turning handle, then lock with the knurled locknut. Available in three handle styles.

## **DETENT PINS**

Economical locating pin. Locking balls are spring loaded, not positive locking. Simply push pin to insert, pull to remove. 3/16 to 1" diameters standard. Available in alloy or stainless steel.

## **EXPANDING PINS**

Precision alignment pin. Diameter expands up to .006 inches by moving handle. Positive cam action expands split bushings to lock pin in place.

## **LIFTING PINS**

Single-acting ball lock pin with one-piece body and four balls for high tension loads. Sturdy forged shackle for heavy lifting.



# METRIC PREFIXES

Prefix	Symbol	Multiplier
tera	T	1,000,000,000,000
giga	G	1,000,000,000
mega	M	1,000,000
kilo	k	1,000
hecto	h	100
deka	da	10
		1
deci	d	.1
centi	c	.01
milli	m	.001
micro	$\mu$	.000001
nano	n	.000000001
pico	p	.000000000001

# CONVERSION FACTORS

Multiply	By	To Obtain
----------	----	-----------

## A

A	1	Amperes
Abcoulombs	$2.998 \times 10^{10}$	Statcoulombs
Acre-feet	43,560	Cubic feet
Acre-feet	1233.49	Cubic meters
Acre-feet	325,851	Gallons
Acres	.4047	Hectares
Acres	43,560	Square feet
Acres	4,047	Square meters
Acres	.001562	Square miles
Acres	4,840	Square yards
Ampere-hours	3,600	Coulombs
Ampere-hours	.03731	Faradays
Ampere-turns	1.257	Gilberts
Angstrom unit	$3.937 \times 10^{-9}$	Inches
Angstrom unit	$10^{-10}$	Meters
Ares	.02471	Acres
Ares	100	Sq. meters
Astronomical units	$1.495 \times 10^8$	Kilometers
Atmospheres	1.01325	Bars
Atmospheres	76.0	Cm. of mercury
Atmospheres	33.90	Feet of water
Atmospheres	29.92	Inches of mercury
Atmospheres	10,333	Kilograms/sq. meter
Atmospheres	101.325	KiloPascals
Atmospheres	101,325	Pascals
Atmospheres	14.70	Pounds/sq. inch
Atmospheres	1.058	Tons/sq. foot

## B

Bags (cement)	94	Pounds
Barrels (cement)	376	Pounds
Barrels (dry)	7056	Cubic inches
Barrels (dry)	105.0	Quarts (dry)
Barrels (liquid)	31.5	Gallons
Barrels (oil)	42	Gallons
Bars	.9869	Atmospheres
Bars	1,000,000	Dynes/sq. centimeter
Bars	10,200	Kilograms/sq. meter
Bars	100	KiloPascals
Bars	750.0	Millimeters of mercury
Bars	100,000	Pascals
Bars	14.50	Pounds/sq. inch

<b>Multiply</b>	<b>By</b>	<b>To Obtain</b>
Baryls	1	Dynes/sq. centimeter
Board feet	144	Cubic inches
Bolts (US Cloth)	40	Yards
B.T.U.	1.055x10 <sup>10</sup>	Ergs
B.T.U.	778.2	Foot-pounds
B.T.U.	252.2	Gram calories
B.T.U.	3.930x10 <sup>-4</sup>	Horsepower-hours
B.T.U.	1,055	Joules
B.T.U.	.2522	Kilocalories
B.T.U.	107.6	Kilogram-meters
B.T.U.	2.931x10 <sup>-4</sup>	Kilowatt-hours
B.T.U.	10.409	Liter-Atmospheres
B.T.U./hour	.2162	Foot-pounds/second
B.T.U./hour	.0700	Gram-calories/second
B.T.U./hour	3.930x10 <sup>-4</sup>	Horsepower
B.T.U./hour	.2931	Watts
B.T.U./minute	12.97	Foot-pounds/second
B.T.U./minute	.02358	Horsepower
B.T.U./minute	.01758	Kilowatts
B.T.U./minute	17.58	Watts
B.T.U./sq. foot/minute	.1221	Watts/sq. inch
Buckets (British, Dry)	18.18	Liters
Bushels	1.2445	Cu. feet
Bushels	2150.4	Cu. inches
Bushels	.03524	Cu. meters
Bushels	35.24	Liters
Bushels	4	Pecks
Bushels	64	Pints (dry)
Bushels	32	Quarts (dry)

## C

C	1	Coulombs
Calories (gram)	.003966	B.T.U
Calories (gram)	.001	Calories (kilogram)
Calories (gram)	41,840,000	Ergs
Calories (gram)	.001	Food calories
Calories (gram)	3.0860	Foot-pounds
Calories (gram)	1.559x10 <sup>-6</sup>	Horsepower-hours
Calories (gram)	.001	Kilocalories
Calories (gram)	1.162x10 <sup>-6</sup>	Kilowatt-hours
Calories (kilogram)	3.966	B.T.U.
Calories (kilogram)	1,000	Calories (gram)
Calories (kilogram)	1	Food calories
Calories (kilogram)	3,086	Foot-pounds
Calories (kilogram)	.001559	Horsepower-hours
Calories (kilogram)	4,184	Joules
Calories (kilogram)	1	Kilocalories

<b>Multiply</b>	<b>By</b>	<b>To Obtain</b>
Calories (kilogram)	426.8	Kilogram-meters
Calories (kilogram)	.001162	Kilowatt-hours
Candela/sq. centimeter	3.142	Lamberts
Candela/sq. inch	.4869	Lamberts
Candela/sq. meter	.0003142	Lamberts
Carats	3.086	Grains
Centares (Centiares)	1	Square meters
Centigrams	.01	Grams
Centiliters	.01	Liters
Centimeter-dynes	.00102	Centimeter-grams
Centimeter-dynes	$1.020 \times 10^{-8}$	Meter-kilograms
Centimeter-dynes	$7.376 \times 10^{-8}$	Pound-feet
Centimeter-grams	980.7	Centimeter-dynes
Centimeter-grams	$10^{-5}$	Meter-kilograms
Centimeter-grams	$7.233 \times 10^{-5}$	Pound-feet
Centimeters	.03281	Feet
Centimeters	.3937	Inches
Centimeters	.01	Meters
Centimeters	10	Millimeters
Centimeters	393.7	Mils
Centimeters of mercury	.01316	Atmospheres
Centimeters of mercury	.4461	Feet of water
Centimeters of mercury	136.0	Kilograms/sq. meter
Centimeters of mercury	27.85	Pounds/sq. foot
Centimeters of mercury	.1934	Pounds/sq. inch
Centimeters/second	1.969	Feet/minute
Centimeters/second	.03281	Feet/second
Centimeters/second	.036	Kilometers/hour
Centimeters/second	.6	Meters/minute
Centimeters/second	.02237	Miles/hour
Centimeters/second	$3.728 \times 10^{-4}$	Miles/minute
Centimeters/sec./sec.	.03281	Feet/sec./sec.
Centipoise	1	Millipascal-seconds
Centipoise	.001	Pascal-seconds
Centistokes	$10^{-6}$	Sq. meters/second
Centistokes	1	Sq. millimeters/second
Chains	792	Inches
Chains	20.12	Meters
Chains	22	Yards
Circular mils	$5.067 \times 10^{-6}$	Sq. centimeters
Circular mils	$7.854 \times 10^{-7}$	Sq. inches
Circular mils	.7854	Sq. mils
Circumference	6.2832	Radians
Cord feet	16	Cu. feet
Cords	8	Cord feet
Coulombs	$1.036 \times 10^{-5}$	Faradays
Coulombs	$2.998 \times 10^9$	Statcoulombs
Coulombs/sq. centimeter	64.52	Coulombs/sq. inch

<b>Multiply</b>	<b>By</b>	<b>To Obtain</b>
Coulombs/sq. inch	.1550	Coulombs/sq. cm
Cubic centimeters	$3.531 \times 10^{-5}$	Cubic feet
Cubic centimeters	.06102	Cubic inches
Cubic centimeters	.000001	Cubic meters
Cubic centimeters	$1.308 \times 10^{-6}$	Cubic yards
Cubic centimeters	$2.642 \times 10^{-4}$	Gallons
Cubic centimeters	.001	Liters
Cubic centimeters	.002113	Pints (liquid)
Cubic centimeters	.001057	Quarts (liquid)
Cubic feet	.8036	Bushels (dry)
Cubic feet	28,320	Cubic centimeters
Cubic feet	1728	Cubic inches
Cubic feet	.02832	Cubic meters
Cubic feet	.03704	Cubic yards
Cubic feet	7.48052	Gallons
Cubic feet	28.32	Liters
Cubic feet	59.84	Pints (liquid)
Cubic feet	62.43	Pounds of water
Cubic feet	29.92	Quarts (liquid)
Cubic feet/minute	472.0	Cu. centimeters/second
Cubic feet/minute	.1247	Gallons/second
Cubic feet/minute	.4720	Liters/second
Cubic feet/minute	62.43	Pounds of water/minute
Cubic feet/second	.646317	Millions of gallons/day
Cubic feet/second	448.831	Gallons/minute
Cubic inches	16.39	Cubic centimeters
Cubic inches	$5.787 \times 10^{-4}$	Cubic feet
Cubic inches	$1.639 \times 10^{-5}$	Cubic meters
Cubic inches	$2.143 \times 10^{-5}$	Cubic yards
Cubic inches	.004329	Gallons
Cubic inches	.01639	Liters
Cubic inches	106,100	Mil-feet
Cubic inches	.03463	Pints (liquid)
Cubic inches	.01732	Quarts (liquid)
Cubic meters	28.38	Bushels (dry)
Cubic meters	1,000,000	Cubic centimeters
Cubic meters	35.31	Cubic feet
Cubic meters	61,023	Cubic inches
Cubic meters	1.308	Cubic yards
Cubic meters	264.2	Gallons
Cubic meters	1000	Liters
Cubic meters	2113	Pints (liquid)
Cubic meters	1057	Quarts (liquid)
Cubic yards	764,600	Cubic centimeters
Cubic yards	27	Cubic feet
Cubic yards	46,656	Cubic inches

<b>Multiply</b>	<b>By</b>	<b>To Obtain</b>
Cubic yards	.7646	Cubic meters
Cubic yards	202.0	Gallons
Cubic yards	764.6	Liters
Cubic yards	1616	Pints (liquid)
Cubic yards	807.9	Quarts (liquid)
Cubic yards/minute	.45	Cubic feet/second
Cubic yards/minute	3.367	Gallons/second
Cubic yards/minute	12.74	Liters/second
Cycles/second	1	Hertz

## D

Days	86,400	Seconds
Decigrams	.1	Grams
Deciliters	.1	Liters
Decimeters	.1	Meters
Degrees (angle)	60	Minutes
Degrees (angle)	.01111	Quadrants
Degrees (angle)	.01745	Radians
Degrees (angle)	3600	Seconds
Degrees (Celsius)	$(^{\circ}\text{C} \times 9/5) + 32$	Degrees (Fahrenheit)
Degrees (Celsius)	$^{\circ}\text{C} + 273.15$	Degrees (Kelvin)
Degrees (Fahrenheit)	$(^{\circ}\text{F} - 32) \times 5/9$	Degrees (Celsius)
Degrees (Fahrenheit)	$^{\circ}\text{F} + 459.67$	Degrees (Rankine)
Degrees (Kelvin)	$^{\circ}\text{K} - 273.15$	Degrees (Celsius)
Degrees (Rankine)	$^{\circ}\text{R} - 459.67$	Degrees (Fahrenheit)
Degrees/second (angle)	.01745	Radians/second
Degrees/second (angle)	.1667	Revolutions/minute
Degrees/second (angle)	.002778	Revolutions/second
Dekagrams	10	Grams
Dekaliters	10	Liters
Dekameters	10	Meters
Drams	27.34375	Grains
Drams	1.771845	Grams
Drams	.0625	Ounces
Drams (troy)	.1371429	Ounces
Drams (troy)	.125	Ounces (troy)
Dyne-centimeters	1	Ergs
Dynes	1	Gram-cm./sec <sup>2</sup>
Dynes	10 <sup>-7</sup>	Joules/centimeter
Dynes	1.020x10 <sup>-6</sup>	Kilograms
Dynes	10 <sup>-5</sup>	Newtons
Dynes	7.233x10 <sup>-5</sup>	Poundals
Dynes	2.248x10 <sup>-6</sup>	Pounds
Dynes/centimeter	.01	Ergs/sq. millimeter
Dynes/sq. centimeter	9.869x10 <sup>-7</sup>	Atmospheres
Dynes/sq. centimeter	10 <sup>-6</sup>	Bars

Multiply	By	To Obtain
----------	----	-----------

## E

Em (Pica)	.4233	Centimeters
Em (Pica)	.167	Inches
Ergs	$9.478 \times 10^{-11}$	B.T.U.
Ergs	$2.390 \times 10^{-8}$	Calories (gram)
Ergs	1	Dyne-centimeters
Ergs	$7.376 \times 10^{-8}$	Foot-pounds
Ergs	.00102	Gram-centimeters
Ergs	$3.725 \times 10^{-14}$	Horsepower-hours
Ergs	$10^{-7}$	Joules
Ergs	$2.390 \times 10^{-11}$	Kilocalories
Ergs	$1.020 \times 10^{-8}$	Kilogram-meters
Ergs	$2.778 \times 10^{-14}$	Kilowatt-hrs.
Ergs	$2.778 \times 10^{-11}$	Watt-hours
Ergs/second	$5.688 \times 10^{-9}$	B.T.U./minute
Ergs/second	1	Dyne-cm./sec.
Ergs/second	$4.427 \times 10^{-6}$	Foot-pounds/minute
Ergs/second	$7.3756 \times 10^{-8}$	Foot-pounds/second
Ergs/second	$1.341 \times 10^{-10}$	Horsepower
Ergs/second	$1.433 \times 10^{-9}$	Kilocalories/minute

## F

F	1	Farads
Faradays	26.80	Ampere-hours
Faradays	96,490	Coulombs
Faradays/sec.	96,490	Amperes
Farads	1,000,000	Microfarads
Fathoms	1.8288	Meters
Fathoms	6	Feet
Feet	30.48	Centimeters
Feet	12	Inches
Feet	$3.048 \times 10^{-4}$	Kilometers
Feet	.3048	Meters
Feet	$1.894 \times 10^{-4}$	Miles
Feet	$1.645 \times 10^{-4}$	Miles (nautical)
Feet	304.8	Millimeters
Feet	.3333	Yards
Feet of water	.02950	Atmospheres
Feet of water	.8826	Inches of mercury
Feet of water	.03048	Kilograms/sq. cm.
Feet of water	304.8	Kilograms/sq. meter
Feet of water	62.43	Pounds/sq. foot
Feet of water	.4335	Pounds/sq. inch
Feet/minute	.5080	Centimeters/second
Feet/minute	.01667	Feet/second
Feet/minute	.01829	Kilometers/hour

<b>Multiply</b>	<b>By</b>	<b>To Obtain</b>
Feet/minute	.3048	Meters/minute
Feet/minute	.01136	Miles/hour
Feet/second	30.48	Centimeters/second
Feet/second	1.097	Kilometers/hour
Feet/second	.5921	Knots
Feet/second	18.29	Meters/minute
Feet/second	.6818	Miles/hour
Feet/second	.01136	Miles/minute
Feet/sec./sec.	30.48	Centimeters/sec./sec.
Feet/sec./sec.	.3048	Meters/sec./sec.
Feet/sec./sec.	1.097	Kilometers/hr./sec.
Feet/sec./sec.	.6818	Miles/hour/sec.
Foot candles	10.764	Lumens/sq. meter
Footlamberts	3.426	Candela/square meter
Foot-pounds	.001285	B.T.U.
Foot-pounds	13,560,000	Ergs
Foot-pounds	.3240	Gram calories
Foot-pounds	$5.051 \times 10^{-7}$	Horsepower-hours
Foot-pounds	1.356	Joules
Foot-pounds	$3.240 \times 10^{-4}$	Kilocalories
Foot-pounds	.1383	Kilogram-meters
Foot-pounds	$3.766 \times 10^{-7}$	Kilowatt-hours
Foot-pounds	1.356	Newton-meters
Foot-pounds/minute	.001285	B.T.U./minute
Foot-pounds/minute	.01667	Foot-pounds/sec.
Foot-pounds/minute	$3.030 \times 10^{-5}$	Horsepower
Foot-pounds/minute	$3.240 \times 10^{-4}$	Kilocalories/minute
Foot-pounds/minute	$2.260 \times 10^{-5}$	Kilowatts
Foot-pounds/second	.07710	B.T.U./minute
Foot-pounds/second	4.6262	B.T.U./hour
Foot-pounds/second	.001818	Horsepower
Foot-pounds/second	.01944	Kilocalories/minute
Foot-pounds/second	.001356	Kilowatts
Furlongs	660	Feet
Furlongs	.125	Miles
Furlongs	40	Rods

## G

g's (gravity)	32.174	feet/sec/sec
g's (gravity)	9.806650	meters/sec/sec
Gallons	3785	Cubic centimeters
Gallons	.1337	Cubic feet
Gallons	231.0	Cubic inches
Gallons	.003785	Cubic meters
Gallons	.004951	Cubic yards
Gallons	.83267	Gallons (Imperial)
Gallons	3.785	Liters



<b>Multiply</b>	<b>By</b>	<b>To Obtain</b>
Gallons	8	Pints (liquid)
Gallons	8.3453	Pounds of water
Gallons	4	Quarts (liquid)
Gallons (Imperial)	1.20095	Gallons
Gallons/minute	8.0208	Cubic feet/hour
Gallons/minute	.002228	Cubic feet/second
Gallons/minute	.06308	Liters/sec.
Gallons/minute	6.0086	Tons of water/24 hrs.
Gausses	6.452	Lines/sq. inch
Gausses	$10^{-8}$	Teslas
Gausses	$10^{-8}$	Webers/sq. cm.
Gausses	$6.452 \times 10^{-8}$	Webers/sq. in.
Gausses	$10^{-4}$	Webers/sq. meter
Gilberts	.7958	Ampere-turns
Gilberts/centimeter	.7958	Ampere-turns/cm.
Gilberts/centimeter	2.021	Ampere-turns/inch
Gilberts/centimeter	79.58	Ampere-turns/meter
Gills	.1183	Liters
Gills	.25	Pints (liquid)
Gills (British)	142.07	Cu. centimeters
Grade percentage	.9001	Degrees
Grains	.0365714	Drams
Grains	.06480	Grams
Grains	.002083	Ounces (troy)
Grains	.04167	Pennyweights (troy)
Grains (troy)	1	Grains
Grains/gallon	17.118	Parts/million
Grains/gallon	142.86	Pounds/million gallons
Grains/Imp. gallon	14.254	Parts/million
Gram-centimeters	$9.295 \times 10^{-8}$	B.T.U.
Gram-centimeters	980.7	Ergs
Gram-centimeters	$2.344 \times 10^{-8}$	Kilocalories
Gram-centimeters	$10^{-5}$	Kilogram-meters
Gram-centimeters/sec. <sup>2</sup>	1	Dynes
Grams	980.7	Dynes
Grams	15.43	Grains
Grams	.001	Kilograms
Grams	1000	Milligrams
Grams	.03527	Ounces
Grams	.03215	Ounces (troy)
Grams	.07093	Poundals
Grams	.002205	Pounds
Grams/centimeter	.005600	Pounds/inch
Grams/cu. centimeter	62.43	Pounds/cubic foot
Grams/cu. centimeter	.03613	Pounds/cubic inch
Grams/liter	58.417	Grains/gallon
Grams/liter	8.345	Pounds/1000 gallons
Grams/liter	.062427	Pounds/cubic foot

<b>Multiply</b>	<b>By</b>	<b>To Obtain</b>
Grams/liter	1000	Parts/million
Grams/sq. centimeter	2.0481	Pounds/sq. foot

## H

H	1	Henries
Hands	4	Inches
Hectares	2.471	Acres
Hectares	10,000	Square meters
Hectares	107,600	Square feet
Hectograms	100	Grams
Hectoliters	100	Liters
Hectometers	100	Meters
Hectowatts	100	Watts
Hertz	1	Cycles/second
Hogsheads	8.42184	Cubic feet
Hogsheads	63	Gallons
Hogsheads (British)	10.114	Cubic feet
Horsepower	42.41	B.T.U./minute
Horsepower	33,000	Foot-pounds/min.
Horsepower	550	Foot-pounds/sec.
Horsepower	1.014	Horsepower (metric)
Horsepower	10.69	Kilocalories/minute
Horsepower	.7457	Kilowatts
Horsepower	745.7	Watts
Horsepower (boiler)	33,479	B.T.U./hour
Horsepower (boiler)	9.803	Kilowatts
Horsepower (metric)	.9863	Horsepower
Horsepower-hours	2544	B.T.U.
Horsepower-hours	641,600	Calories (gram)
Horsepower-hours	$2.685 \times 10^{13}$	Ergs
Horsepower-hours	1,980,000	Foot-pounds
Horsepower-hours	2,684,520	Joules
Horsepower-hours	641.6	Kilocalories
Horsepower-hours	273,700	Kilogram-meters
Horsepower-hours	.7457	Kilowatt-hours
Hundredweights	1600	Ounces
Hundredweights	100	Pounds
Hundredweights	.05	Tons
Hundredweights	.0446429	Tons (long)
Hundredweights	.0453592	Tons (metric)
Hundredweights (long)	112	Pounds
Hundredweights (long)	.05	Tons (long)

## I

Inches	2.54	Centimeters
Inches	.0254	Meters

<b>Multiply</b>	<b>By</b>	<b>To Obtain</b>
Inches	25.4	Millimeters
Inches	1,000	Mils
Inches	.02778	Yards
Inches of mercury	.03342	Atmospheres
Inches of mercury	1.133	Feet of water
Inches of mercury	.03453	Kilograms/sq. cm.
Inches of mercury	345.3	Kilograms/sq. meter
Inches of mercury	70.73	Pounds/sq. foot
Inches of mercury	.4912	Pounds/sq. inch
Inches of water	.002458	Atmospheres
Inches of water	.07355	Inches of mercury
Inches of water	25.40	Kilograms/sq. meter
Inches of water	.5781	Ounces/sq. inch
Inches of water	5.202	Pounds/sq. foot
Inches of water	.03613	Pounds/sq. inch

## J

J	1	Joules
Joules	$9.478 \times 10^{-4}$	B.T.U.
Joules	10,000,000	Ergs
Joules	.7376	Foot-pounds
Joules	$3.725 \times 10^{-7}$	Horsepower-hours
Joules	$2.390 \times 10^{-4}$	Kilocalories
Joules	.1020	Kilogram-meters
Joules	$2.778 \times 10^{-7}$	Kilowatt-hours
Joules	1	Newton-meters
Joules	$2.778 \times 10^{-4}$	Watt-hours

## K

Kilocalories	3.966	B.T.U.
Kilocalories	1	Food calories
Kilocalories	3086	Foot-pounds
Kilocalories	1000	Gram calories
Kilocalories	.001559	Horsepower-hours
Kilocalories	4,184	Joules
Kilocalories	1	Kilogram calories
Kilocalories	426.9	Kilogram-meters
Kilocalories	4.184	Kilojoules
Kilocalories	.001162	Kilowatt-hours
Kilocalories/minute	51.43	Foot-pounds/second
Kilocalories/minute	.09351	Horsepower
Kilocalories/minute	.06973	Kilowatts
Kilogram-meters	7.231	Foot-pounds
Kilogram-meters/sec. <sup>2</sup>	1	Newtons
Kilograms	1000	Grams
Kilograms	70.93	Poundals

<b>Multiply</b>	<b>By</b>	<b>To Obtain</b>
Kilograms	2.205	Pounds
Kilograms	.001102	Tons
Kilograms/cu. meter	.001	Grams/cu. centimeter
Kilograms/cu. meter	.06243	Pounds/cu. foot
Kilograms/cu. meter	$3.613 \times 10^{-5}$	Pounds/cu. inch
Kilograms/meter	.6720	Pounds/foot
Kilograms/sq. cm.	.9678	Atmospheres
Kilograms/sq. cm.	980,665	Dynes
Kilograms/sq. cm.	32.81	Feet of water
Kilograms/sq. cm.	28.96	Inches of mercury
Kilograms/sq. cm.	2,048	Pounds/sq. foot
Kilograms/sq. cm.	14.22	Pounds/sq. inch
Kilograms/sq. meter	$9.678 \times 10^{-5}$	Atmospheres
Kilograms/sq. meter	$9.807 \times 10^{-5}$	Bars
Kilograms/sq. meter	.003281	Feet of water
Kilograms/sq. meter	.002896	Inches of mercury
Kilograms/sq. meter	.2048	Pounds/sq. foot
Kilograms/sq. meter	.001422	Pounds./sq. inch
Kilograms/sq. millimeter	1,000,000	Kilograms/sq. meter
Kilolines	1000	Maxwells
Kiloliters	1000	Liters
Kilometers	100,000	Centimeters
Kilometers	3281	Feet
Kilometers	1000	Meters
Kilometers	.6214	Miles
Kilometers	1094	Yards
Kilometers/hour	27.78	Centimeters/second
Kilometers/hour	54.68	Feet/minute
Kilometers/hour	.9113	Feet/second
Kilometers/hour	.5396	Knots
Kilometers/hour	16.67	Meters/minute
Kilometers/hour	.6214	Miles/hour
Kilometers/hr./sec.	27.78	Centimeters/sec./sec.
Kilometers/hr./sec.	.9113	Feet/sec./sec.
Kilometers/hr./sec.	.2778	Meters/sec./sec.
Kilometers/liter	2.352	Miles/gallon
KiloNewtons	224.8	Pounds
KiloPascals	.1450	Pounds/sq. inch
Kilowatt-hours	3412	B.T.U.
Kilowatt-hours	$3.600 \times 10^{13}$	Ergs
Kilowatt-hours	2,655,000	Foot-pounds
Kilowatt-hours	1.341	Horsepower-hours
Kilowatt-hours	3,600,000	Joules
Kilowatt-hours	860.4	Kilocalories
Kilowatt-hours	367,100	Kilogram-meters
Kilowatts	56.87	B.T.U./minute
Kilowatts	44,250	Foot-pounds/minute
Kilowatts	737.6	Foot-pounds/second

<b>Multiply</b>	<b>By</b>	<b>To Obtain</b>
Kilowatts	1.341	Horsepower
Kilowatts	14.34	Kilocalories/minute
Kilowatts	1000	Watts
Knots	1.689	Feet/second
Knots	1.8532	Kilometers/hr.
Knots	1.151	Miles/hour
Knots	1	Nautical miles/hour

## L

Lamberts	.3183	Candela/sq. centimeter
Lamberts	2.054	Candela/sq. inch
Lamberts	3183	Candela/sq. meter
Leagues	3	Miles (nautical)
Light years	$9.4609 \times 10^{12}$	Kilometers
Light years	$5.9 \times 10^{12}$	Miles
Lines/sq. centimeter	1	Gausses
Lines/sq. inch	.1550	Gausses
Lines/sq. inch	$1.550 \times 10^{-9}$	Webers/sq. centimeter
Lines/sq. inch	$10^{-8}$	Webers/sq. inch
Links (engineer's)	12	Inches
Links (surveyor's)	7.92	Inches
Liters	1000	Cubic centimeters
Liters	.03531	Cubic feet
Liters	61.02	Cubic inches
Liters	.001	Cubic meters
Liters	.001308	Cubic yards
Liters	.2642	Gallons
Liters	1.000	Kilograms of water
Liters	2.113	Pints (liquid)
Liters	1.057	Quarts (liquid)
Liters/minute	$5.886 \times 10^{-4}$	Cu. feet/second
Liters/minute	.004403	Gallons/second
Lumens	.07958	Spherical candle power
Lumens	.001496	Watts
Lumens/sq. foot	1	Foot-candles
Lumens/sq. foot	10.76	Lumens/sq. meter
Lux	.0929	Foot-candles

## M

Maxwells	.001	Kilolines
Maxwells	$10^{-8}$	Webers
Megajoules	.2778	Kilowatt-hours
Megalines	1,000,000	Maxwells
MegaPascals	145.0	Pounds/sq. inch
Meter-kilograms	98,070,000	Centimeter-dynes
Meter-kilograms	100,000	Centimeter-grams

<b>Multiply</b>	<b>By</b>	<b>To Obtain</b>
Meter-kilograms	7.233	Pound-feet
Meters	100	Centimeters
Meters	3.281	Feet
Meters	39.37	Inches
Meters	.001	Kilometers
Meters	$6.214 \times 10^{-4}$	Miles
Meters	$5.396 \times 10^{-4}$	Miles (nautical)
Meters	1000	Millimeters
Meters	1.094	Yards
Meters/minute	1.667	Centimeters/second
Meters/minute	3.281	Feet/minute
Meters/minute	.05468	Feet/second
Meters/minute	.06	Kilometers/hour
Meters/minute	.03238	Knots
Meters/minute	.03728	Miles/hour
Meters/second	196.8	Feet/minute
Meters/second	3.281	Feet/second
Meters/second	3.6	Kilometers/hour
Meters/second	.06	Kilometers/minute
Meters/second	2.237	Miles/hour
Meters/second	.03728	Miles/minute
Meters/sec./sec.	3.281	Feet/sec./sec.
Meters/sec./sec.	3.6	Kilometers/hr./sec.
Meters/sec./sec.	2.237	Miles/hour/sec.
Mhos	1	Siemens
Microfarads	$10^{-6}$	Farads
Microns	$10^{-6}$	Meters
Mil-feet	$9.425 \times 10^{-6}$	Cu. inches
Miles	160,900	Centimeters
Miles	5280	Feet
Miles	63,360	Inches
Miles	1.609	Kilometers
Miles	1,609	Meters
Miles	.8684	Miles (nautical)
Miles	1760	Yards
Miles (nautical)	6,080.27	Feet
Miles (nautical)	1.853	Kilometers
Miles (nautical)	1,853	Meters
Miles (nautical)	1.1516	Miles
Miles (nautical)	2,027	Yards
Miles/gallon	.4251	Kilometers/liter
Miles/hour	44.70	Centimeters/second
Miles/hour	88	Feet/minute
Miles/hour	1.467	Feet/second
Miles/hour	1.609	Kilometers/hour
Miles/hour	.8684	Knots
Miles/hour	26.82	Meters/minute
Miles/hour	.1667	Miles/minute

<b>Multiply</b>	<b>By</b>	<b>To Obtain</b>
Miles/hour/sec.	44.70	Centimeters/sec./sec.
Miles/hour/sec.	1.467	Feet/sec./sec.
Miles/hour/sec.	1.609	Kilometers/hr./sec.
Miles/hour/sec.	.4470	Meters/sec./sec.
Miles/minute	2682	Centimeters/second
Miles/minute	88	Feet/second
Miles/minute	1.609	Kilometers/minute
Miles/minute	60	Miles/hour
Milliers	1000	Kilograms
Milligrams	.01543	Grains
Milligrams	.001	Grams
Milligrams/liter	1	Parts/million
Milliliters	.001	Liters
Millimeters	.1	Centimeters
Millimeters	.03937	Inches
Millimeters	.003281	Feet
Millimeters	39.37	Mils
Millimeters of mercury	.001316	Atmospheres
Millimeters of mercury	.001333	Bars
Millimeters of mercury	.04461	Feet of water
Millimeters of mercury	13.60	Kilograms/sq. meter
Millimeters of mercury	133.3	Pascals
Millimeters of mercury	.01934	Pounds/sq. inch
Millimicrons	10 <sup>-9</sup>	Meters
Million gallons/day	1.54723	Cu. feet/second
Mils	.00254	Centimeters
Mils	.001	Inches
Miner's inches	1.5	Cu. feet/minute
Minims	.061612	Cu. centimeters
Minims (British)	.059192	Cu. centimeters
Minutes (angle)	.01667	Degrees
Minutes (angle)	1.852x10 <sup>-4</sup>	Quadrants
Minutes (angle)	2.909x10 <sup>-4</sup>	Radians
Minutes (angle)	60	Seconds

## N

N	1	Newtons
Nepers	8.686	Decibels
Newton-meters	.7376	Foot-pounds
Newton-meters	1	Joules
Newtons	100,000	Dynes
Newtons	.1020	Kilograms
Newtons	1	Kilogram-meters/sec <sup>2</sup>
Newtons	.2248	Pounds
Newtons/sq. meter	1	Pascals

Multiply	By	To Obtain
----------	----	-----------

## O

Oersteds	79.58	Amperes/meter
Ounces	16	Drams
Ounces	437.5	Grains
Ounces	28.349527	Grams
Ounces	.9115	Ounces (troy)
Ounces	.0625	Pounds
Ounces	$2.790 \times 10^{-5}$	Tons (long)
Ounces	$2.835 \times 10^{-5}$	Tons (metric)
Ounces (fluid)	1.805	Cubic inches
Ounces (fluid)	.02957	Liters
Ounces (troy)	480	Grains
Ounces (troy)	31.103481	Grams
Ounces (troy)	1.09714	Ounces
Ounces (troy)	20	Pennyweights (troy)
Ounces (troy)	.08333	Pounds (troy)
Ounces/sq. inch	.0625	Pounds/sq. inch

## P

Pa	1	Pascals
Parts/million	.0584	Grains/gallon
Parts/million	.07016	Grains/lmp. gallon
Parts/million	8.345	Pounds/million gallons
Pascals	$9.869 \times 10^{-6}$	Atmospheres
Pascals	.00001	Bars
Pascals	1	Newtons/sq. meter
Pascals	$1.450 \times 10^{-4}$	Pounds/sq. inch
Pecks	.25	Bushels
Pecks	537.605	Cubic inches
Pecks	8.810	Liters
Pecks	8	Quarts (dry)
Pennyweights (troy)	24	Grains
Pennyweights (troy)	1.55517	Grams
Pennyweights (troy)	.05	Ounces (troy)
Pennyweights (troy)	.004167	Pounds (troy)
Pi	1	3.141592654
Picas	.1660	Inches
Pints (dry)	33.60	Cu. inches
Pints (liquid)	473.2	Cu. centimeters
Pints (liquid)	.01671	Cu. feet
Pints (liquid)	28.87	Cu. inches
Pints (liquid)	$6.189 \times 10^{-4}$	Cu. yards
Pints (liquid)	.125	Gallons
Pints (liquid)	.4732	Liters
Pints (liquid)	.5	Quarts (liquid)
Points	.01384	Inches



<b>Multiply</b>	<b>By</b>	<b>To Obtain</b>
Poise	1	Grams/centimeter-sec.
Pound-feet	13,560,000	Centimeter-dynes
Pound-feet	13,825	Centimeter-grams
Pound-feet	.1383	Meter-kilograms
Poundals	13,826	Dynes
Poundals	14.10	Grams
Poundals	.001383	Joules/centimeter
Poundals	.1383	Joules/meter
Poundals	.01410	Kilograms
Poundals	.1383	Newtons
Poundals	.03108	Pounds
Pounds	256	Drams
Pounds	444,823	Dynes
Pounds	7000	Grains
Pounds	453.59237	Grams
Pounds	.04448	Joules/centimeter
Pounds	.45359237	Kilograms
Pounds	.004448	KiloNewtons
Pounds	4.448	Newtons
Pounds	16	Ounces
Pounds	14.5833	Ounces (troy)
Pounds	32.17	Poundals
Pounds	1.21528	Pounds (troy)
Pounds	.0005	Tons
Pounds (troy)	5760	Grains
Pounds (troy)	373.24177	Grams
Pounds (troy)	13.1657	Ounces
Pounds (troy)	12	Ounces (troy)
Pounds (troy)	240	Pennyweights (troy)
Pounds (troy)	.822857	Pounds
Pounds (troy)	4.1143x10 <sup>-4</sup>	Tons
Pounds (troy)	3.6735x10 <sup>-4</sup>	Tons (long)
Pounds (troy)	3.7324x10 <sup>-4</sup>	Tons (metric)
Pounds of water	.01602	Cubic feet
Pounds of water	27.68	Cubic inches
Pounds of water	.1198	Gallons
Pounds of water/min.	2.670x10 <sup>-4</sup>	Cu. feet/second
Pounds/cubic foot	.01602	Grams/cu. centimeter
Pounds/cubic foot	16.02	Kilograms/cu. meter
Pounds/cubic foot	5.787x10 <sup>-4</sup>	Pounds/cu. inch
Pounds/cubic inch	27.68	Grams/cu. centimeter
Pounds/cubic inch	27,680	Kilograms/cu. meter
Pounds/cubic inch	1728	Pounds/cu. foot
Pounds/foot	1.488	Kilograms/meter
Pounds/inch	178.6	Grams/centimeter
Pounds/sq. foot	.01602	Feet of water
Pounds/sq. foot	4.883	Kilograms/sq. meter
Pounds/sq. foot	.006945	Pounds/sq. inch

<b>Multiply</b>	<b>By</b>	<b>To Obtain</b>
Pounds/sq. inch	.06804	Atmospheres
Pounds/sq. inch	.06895	Bars
Pounds/sq. inch	2.307	Feet of water
Pounds/sq. inch	2.036	Inches of mercury
Pounds/sq. inch	703.1	Kilograms/sq. meter
Pounds/sq. inch	6.897	KiloPascals
Pounds/sq. inch	.006897	MegaPascals
Pounds/sq. inch	6897	Pascals

## Q

Quadrants (angle)	90	Degrees
Quadrants (angle)	5400	Minutes
Quadrants (angle)	1.571	Radians
Quarts (dry)	67.20	Cubic inches
Quarts (dry)	1.164	Quarts (liquid)
Quarts (liquid)	946.4	Cubic centimeters
Quarts (liquid)	.03342	Cubic feet
Quarts (liquid)	57.75	Cubic inches
Quarts (liquid)	$9.464 \times 10^{-4}$	Cubic meters
Quarts (liquid)	.25	Gallons
Quarts (liquid)	.9463	Liters
Quarts (liquid)	.8594	Quarts (dry)
Quintals	100	Kilograms
Quintals	220.5	Pounds
Quintals (Argentinean)	101.28	Pounds
Quintals (Brazilian)	129.54	Pounds
Quintals (Peruvian)	101.43	Pounds
Quintals (Chilean)	101.41	Pounds
Quintals (Mexican)	101.47	Pounds
Quires	25	Sheets

## R

Radians	57.30	Degrees
Radians	3438	Minutes
Radians	.6366	Quadrants
Radians/second	57.30	Degrees/second
Radians/second	9.549	Revolutions/minute
Radians/second	.1592	Revolutions/second
Radians/sec./sec.	573.0	Revolutions/min./min.
Radians/sec./sec.	.1592	Revolutions/sec./sec
Reams	500	Sheets
Revolutions	360	Degrees
Revolutions	4	Quadrants
Revolutions	6.283	Radians
Revolutions/minute	6	Degrees/second
Revolutions/minute	.1047	Radians/second

Multiply	By	To Obtain
Revolutions/minute	.01667	Revolutions/second
Revolutions/min./min.	.001745	Radians/sec./sec.
Revolutions/min./min.	2.778x10 <sup>-4</sup>	Revolutions/sec./sec.
Revolutions/second	360	Degrees/second
Revolutions/second	6.283	Radians/second
Revolutions/second	60	Revolutions/minute
Revolutions/sec./sec.	6.283	Radians/sec./sec.
Revolutions/sec./sec.	3600	Revolutions/min./min.
Rods	.25	Chains
Rods	16.5	Feet
Rods	5.029	Meters
Rods	5.5	Yards

## S

S	1	Siemens
Scruples	20	Grains
Seconds (angle)	2.778x10 <sup>-4</sup>	Degrees
Seconds (angle)	.01667	Minutes
Seconds (angle)	3.087x10 <sup>-6</sup>	Quadrants
Seconds (angle)	4.848x10 <sup>-6</sup>	Radians
Siemens	1	Mhos
Slugs	14.59	Kilograms
Slugs	32.17	Pounds
Square centimeters	197,300	Circular mils
Square centimeters	.001076	Square feet
Square centimeters	.1550	Square inches
Square centimeters	10 <sup>-4</sup>	Square meters
Square centimeters	100	Square millimeters
Square feet	2.296x10 <sup>-5</sup>	Acres
Square feet	929.0	Square centimeters
Square feet	144	Square inches
Square feet	.09290	Square meters
Square feet	3.587x10 <sup>-8</sup>	Square miles
Square feet	.1111	Square yards
Square inches	1,273,000	Circular mils
Square inches	6.452	Square centimeters
Square inches	.006944	Square feet
Square inches	645.2	Square millimeters
Square inches	1,000,000	Square mils
Square kilometers	247.1	Acres
Square kilometers	10,760,000	Square feet
Square kilometers	1,000,000	Square meters
Square kilometers	.3861	Square miles
Square kilometers	1,196,000	Square yards
Square meters	2.471x10 <sup>-4</sup>	Acres
Square meters	10.76	Square feet
Square meters	3.861x10 <sup>-7</sup>	Square miles

<b>Multiply</b>	<b>By</b>	<b>To Obtain</b>
Square meters	1.196	Square yards
Square miles	640	Acres
Square miles	27,878,400	Square feet
Square miles	2.590	Square kilometers
Square miles	3,097,600	Square yards
Square millimeters	1,973	Circular mils
Square millimeters	.01	Square centimeters
Square millimeters	.001550	Square inches
Square mils	1.273	Circular mils
Square yards	$2.066 \times 10^{-4}$	Acres
Square yards	9	Square feet
Square yards	1,296	Square inches
Square yards	.8361	Square meters
Square yards	$3.228 \times 10^{-7}$	Square miles
Stokes	.0001	Sq. meters/second

## T

T	1	Teslas
Teslas	1	Webers/sq. meter
Therms	105.5	Megajoules
Tonne	1	Ton (metric)
Tons	907.18486	Kilograms
Tons	32,000	Ounces
Tons	29166.66	Ounces (troy)
Tons	2000	Pounds
Tons	2430.56	Pounds (troy)
Tons	.89286	Tons (long)
Tons	.90718	Tons (metric)
Tons (long)	1016	Kilograms
Tons (long)	2240	Pounds
Tons (long)	1.12	Tons
Tons (metric)	1000	Kilograms
Tons (metric)	2205	Pounds
Tons (register)	100	Cubic feet
Tons (refrigeration)	3.517	Kilowatts
Tons of water/24 hrs.	1.3349	Cu. feet/hour
Tons of water/24 hrs.	.16643	Gallons/minute
Tons of water/24 hrs.	83.333	Pounds water/hr.
Torr	.001333	Bars
Torr	133.3	Pascals
Torr	.01934	Pounds/sq. inch

## V

V	1	Volts
---	---	-------

Multiply	By	To Obtain
----------	----	-----------

## W

W	1	Watts
Watt-hours	3.412	B.T.U.
Watt-hours	860.4	Calories (gram)
Watt-hours	$3.6 \times 10^{10}$	Ergs
Watt-hours	2655	Foot-pounds
Watt-hours	.001341	Horsepower-hours
Watt-hours	.8604	Kilocalories
Watt-hours	367.1	Kilogram-meters
Watt-hours	.001	Kilowatt-hours
Watts	3.412	B.T.U./hour
Watts	.05687	B.T.U./minute
Watts	$10^7$	Ergs/second
Watts	44.25	Foot-pounds/minute
Watts	.7376	Foot-pounds/second
Watts	.001341	Horsepower
Watts	.001360	Horsepower (metric)
Watts	.01434	Kilocalories/minute
Watts	.001	Kilowatts
Wb	1	Webers
Webers	100,000	Kilolines
Webers	$10^8$	Maxwells
Webers/sq. inch	$1.550 \times 10^7$	Gausses
Webers/sq. inch	$10^8$	Lines/sq. inch
Webers/sq. inch	.1550	Webers/sq. centimeter
Webers/sq. inch	1,550	Webers/sq. meter
Webers/sq. meter	10,000	Gausses
Webers/sq. meter	64,520	Lines/sq. inch
Webers/sq. meter	1	Teslas
Webers/sq. meter	.0001	Webers/sq. centimeter
Webers/sq. meter	$6.452 \times 10^{-4}$	Webers/sq. inch

## Y

Yards	91.44	Centimeters
Yards	3	Feet
Yards	36	Inches
Yards	$9.114 \times 10^{-4}$	Kilometers
Yards	.9144	Meters
Yards	$5.682 \times 10^{-4}$	Miles
Yards	$4.934 \times 10^{-4}$	Miles (nautical)

# Featured Products

At CarrLane.com

Carr Lane's Featured Product section provides all of the information you need:

- Product Releases
- Photographs
- Videos
- Catalog Links
- Downloadable Flyers



**CarrLane**<sup>®</sup>

MANUFACTURING CO.  
4200 Carr Lane Ct., P.O. Box 191970 • St. Louis, Missouri 63119-7970 USA  
Phone: 314/647-6200 • Fax: 314/647-5736 • Web Site: www.carrlane.com

**CarrLane.com/Featured**  
Visit today and see what's new!



# TRIGONOMETRY FUNCTIONS

**SINE**

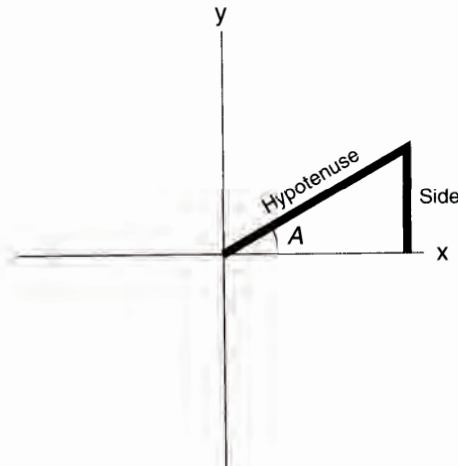

$$\sin A = \frac{\text{Side}}{\text{Hypotenuse}}$$

**COSINE**

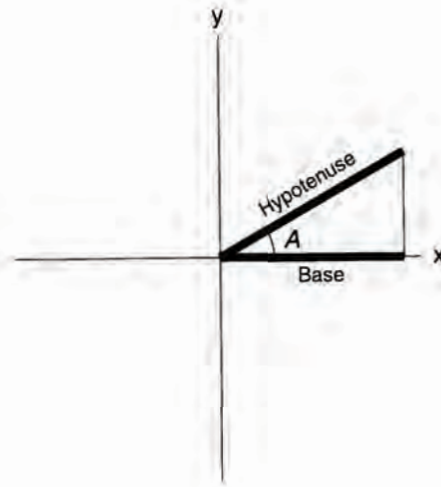

$$\cos A = \frac{\text{Base}}{\text{Hypotenuse}}$$

**TANGENT**

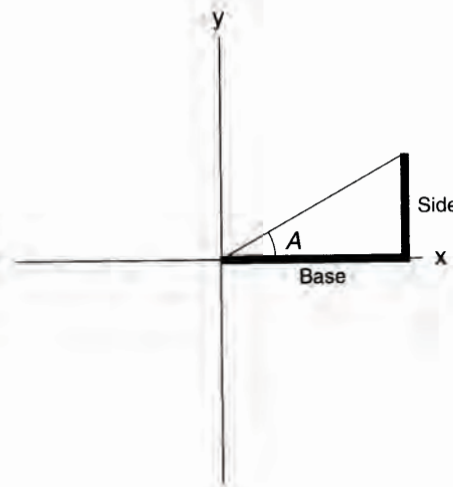

$$\tan A = \frac{\text{Side}}{\text{Base}}$$

# RIGHT TRIANGLES

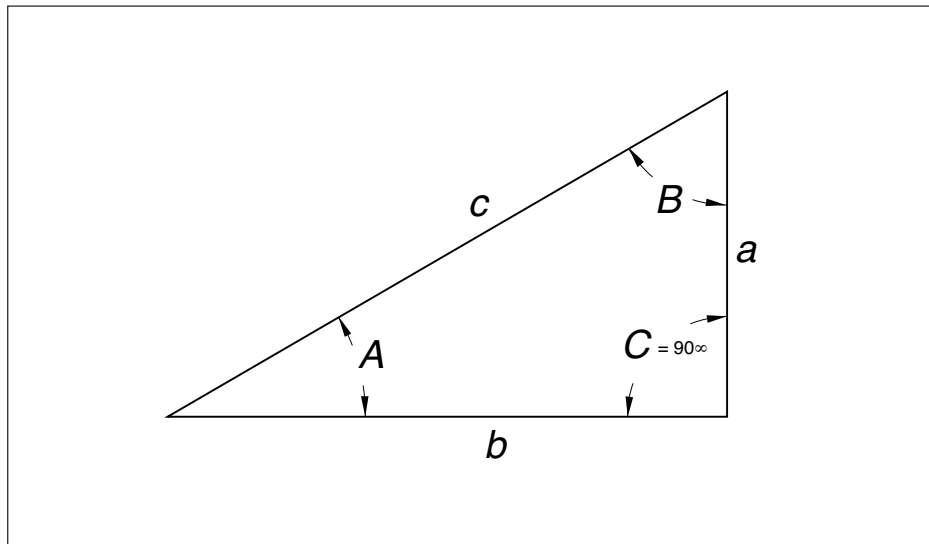

Known Sides and Angles	Unknown Sides and Angles			Area
$a$ and $b$	$c = \sqrt{a^2 + b^2}$	$A = \arctan \frac{a}{b}$	$B = \arctan \frac{b}{a}$	$\frac{a \times b}{2}$
$a$ and $c$	$b = \sqrt{c^2 - a^2}$	$A = \arcsin \frac{a}{c}$	$B = \arccos \frac{a}{c}$	$\frac{a \times \sqrt{c^2 - a^2}}{2}$
$b$ and $c$	$a = \sqrt{c^2 - b^2}$	$A = \arccos \frac{b}{c}$	$B = \arcsin \frac{b}{c}$	$\frac{b \times \sqrt{c^2 - b^2}}{2}$
$a$ and $\angle A$	$b = \frac{a}{\tan A}$	$c = \frac{a}{\sin A}$	$B = 90^\circ - A$	$\frac{a^2}{2 \times \tan A}$
$a$ and $\angle B$	$b = a \times \tan B$	$c = \frac{a}{\cos B}$	$A = 90^\circ - B$	$\frac{a^2 \times \tan B}{2}$
$b$ and $\angle A$	$a = b \times \tan A$	$c = \frac{b}{\cos A}$	$B = 90^\circ - A$	$\frac{b^2 \times \tan A}{2}$
$b$ and $\angle B$	$a = \frac{b}{\tan B}$	$c = \frac{b}{\sin B}$	$A = 90^\circ - B$	$\frac{b^2}{2 \times \tan B}$
$c$ and $\angle A$	$a = c \times \sin A$	$b = c \times \cos A$	$B = 90^\circ - A$	$\frac{c^2 \sin A \cos A}{2}$
$c$ and $\angle B$	$a = c \times \cos B$	$b = c \times \sin B$	$A = 90^\circ - B$	$\frac{c^2 \cos B \sin B}{2}$



# OBLIQUE TRIANGLES

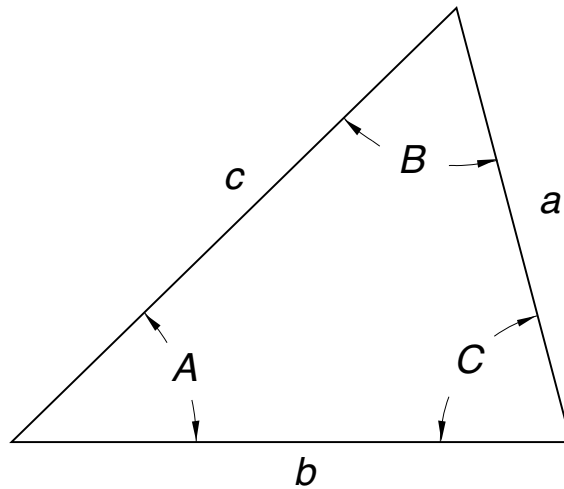

Known Sides and Angles	Unknown Sides and Angles			Area
All three sides $a, b, c$	$A = \arccos \frac{b^2 + c^2 - a^2}{2bc}$	$B = \arcsin \frac{bx \sin A}{a}$	$C = 180^\circ - A - B$	$\frac{a \times b \times \sin C}{2}$
Two sides and the angle between them $a, b, \angle C$	$c = \sqrt{a^2 + b^2 - 2ab \cos C}$	$A = \arctan \frac{a \times \sin C}{b - (a \times \cos C)}$	$B = 180^\circ - A - C$	$\frac{a \times b \times \sin C}{2}$
Two sides and the angle opposite one of the sides $a, b, \angle A$ ( $\angle B$ less than $90^\circ$ )	$B = \arcsin \frac{bx \sin A}{a}$	$C = 180^\circ - A - B$	$c = \frac{a \times \sin C}{\sin A}$	$\frac{a \times b \times \sin C}{2}$
Two sides and the angle opposite one of the sides $a, b, \angle A$ ( $\angle B$ greater than $90^\circ$ )	$B = 180^\circ - \arcsin \frac{bx \sin A}{a}$	$C = 180^\circ - A - B$	$c = \frac{a \times \sin C}{\sin A}$	$\frac{a \times b \times \sin C}{2}$
One side and two angles $a, \angle A, \angle B$	$b = \frac{a \times \sin B}{\sin A}$	$C = 180^\circ - A - B$	$c = \frac{a \times \sin C}{\sin A}$	$\frac{a \times b \times \sin C}{2}$

# **CarrLock™** **SYSTEM**

**Same great  
product, but  
with these  
advantages:**

- Exclusively made in the USA
- Complete interchangeability with all components of the similar mounting system previously offered by Carr Lane
- Now lower price!



# **CarrLane®**

**M A N U F A C T U R I N G C O.**  
4200 Carr Lane Ct., P.O. Box 191970 • St. Louis, Missouri 63119-7970 USA  
Phone: 314/647-6200 • Fax: 314/647-5736 • Web Site: [www.carrlane.com](http://www.carrlane.com)

***CarrLane.com/Featured***



**5-AXIS  
+  
QUICK  
CHANGE  
=  
MAXIMUM  
UTILIZATION**

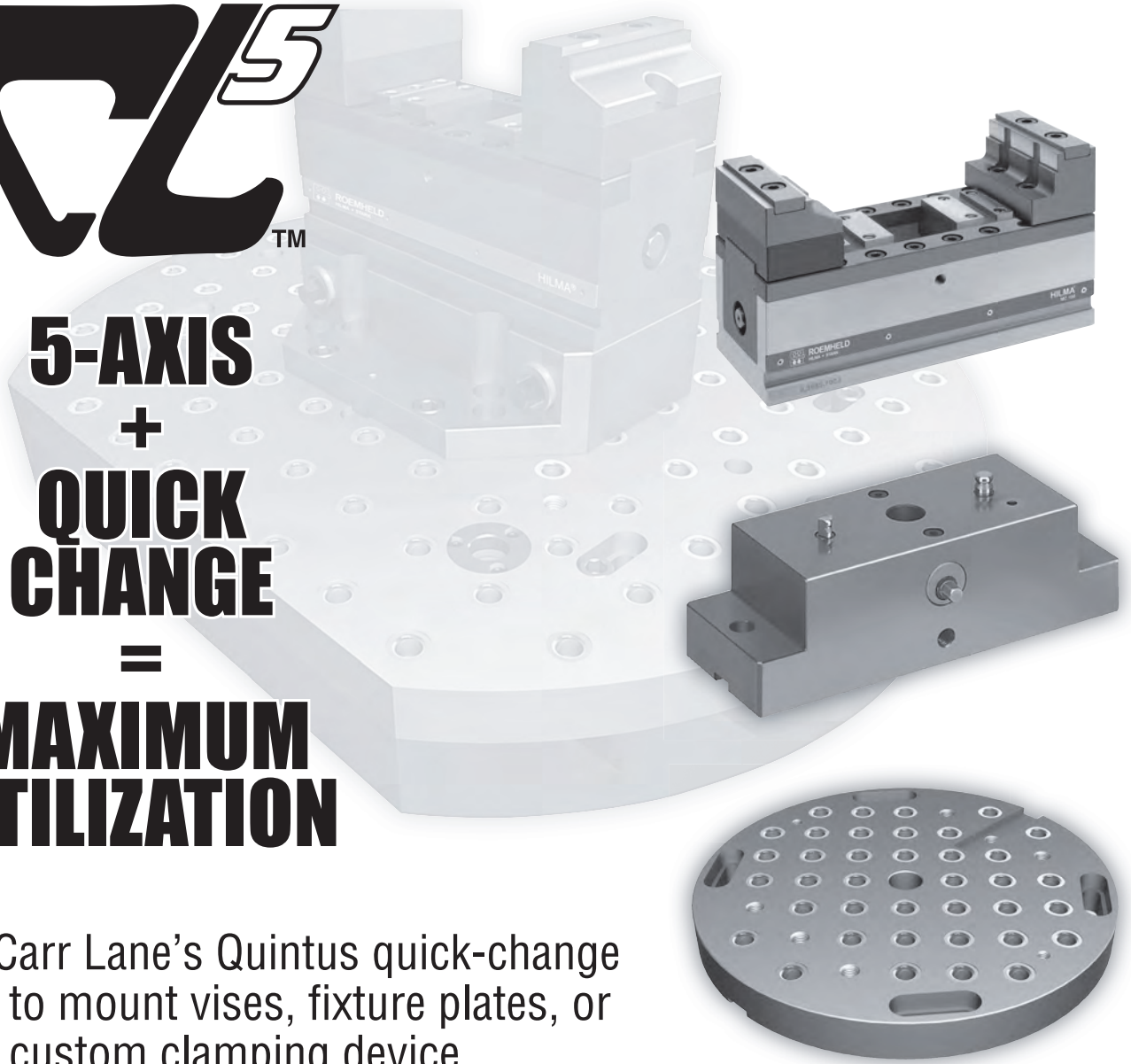

- Use Carr Lane's Quintus quick-change riser to mount vises, fixture plates, or your custom clamping device
- By design, the CL5 system accepts our German-built, extremely accurate vises on precision plates made in the USA
- Achieve 5-side part access and quick-change flexibility
- Numerous jaw types and sizes available



ISO 9001-2008  
CERTIFIED



***CarrLane.com/Featured***

0° Natural Trigonometric Functions

M	Sine	Cosine	Tan.	Cotan.	Secant	Cosec.	M
0	0.00000	1.0000	0.00000	Infinite	1.0000	Infinite	60
1	.00029	.99999	.00029	3437.7	.0000	3437.7	59
2	.00058	.99998	.00058	1718.9	.0000	1718.9	58
3	.00087	.99997	.00087	1145.9	.0000	1145.9	57
4	.00116	.99996	.00116	859.44	.0000	859.44	56
5	0.00145	1.0000	0.00145	687.55	1.0000	687.55	55
6	.00174	.99999	.00174	572.96	.0000	572.96	54
7	.00204	.99998	.00204	491.11	.0000	491.11	53
8	.00233	.99997	.00233	429.72	.0000	429.72	52
9	.00262	.99996	.00262	381.97	.0000	381.97	51
10	0.00291	0.99999	0.00291	343.77	1.0000	343.77	50
11	.00320	.99999	.00320	312.52	.0000	312.52	49
12	.00349	.99999	.00349	286.48	.0000	286.48	48
13	.00378	.99999	.00378	264.44	.0000	264.44	47
14	.00407	.99999	.00407	245.55	.0000	245.55	46
15	0.00436	0.99999	0.00436	229.18	1.0000	229.18	45
16	.00465	.99999	.00465	214.86	.0000	214.86	44
17	.00494	.99999	.00494	202.22	.0000	202.22	43
18	.00524	.99999	.00524	190.98	.0000	190.99	42
19	.00553	.99998	.00553	180.93	.0000	180.93	41
20	0.00582	0.99998	0.00582	171.88	1.0000	171.89	40
21	.00611	.99998	.00611	163.70	.0000	163.70	39
22	.00640	.99998	.00640	156.26	.0000	156.26	38
23	.00669	.99998	.00669	149.46	.0000	149.47	37
24	.00698	.99997	.00698	143.24	.0000	143.24	36
25	0.00727	0.99997	0.00727	137.51	1.0000	137.51	35
26	.00756	.99997	.00756	132.22	.0000	132.22	34
27	.00785	.99997	.00785	127.32	.0000	127.32	33
28	.00814	.99997	.00814	122.77	.0000	122.78	32
29	.00843	.99996	.00844	118.54	.0000	118.54	31
30	0.00873	0.99996	0.00873	114.59	1.0000	114.59	30
31	.00902	.99996	.00902	110.89	.0000	110.90	29
32	.00931	.99996	.00931	107.43	.0000	107.43	28
33	.00960	.99995	.00960	104.17	.0000	104.17	27
34	.00989	.99995	.00989	101.11	.0000	101.11	26
35	0.01018	0.99995	0.01018	98.218	1.0000	98.223	25
36	.01047	.99994	.01047	95.489	.0000	95.495	24
37	.01076	.99994	.01076	92.908	.0000	92.914	23
38	.01105	.99994	.01105	90.463	.0001	90.469	22
39	.01134	.99993	.01134	88.143	.0001	88.149	21
40	0.01163	0.99993	0.01164	85.940	1.0001	85.946	20
41	.01193	.99993	.01193	83.843	.0001	83.849	19
42	.01222	.99992	.01222	81.847	.0001	81.853	18
43	.01251	.99992	.01251	79.943	.0001	79.950	17
44	.01280	.99992	.01280	78.126	.0001	78.133	16
45	0.01309	0.99991	0.01309	76.390	1.0001	76.395	15
46	.01338	.99991	.01338	74.729	.0001	74.735	14
47	.01367	.99991	.01367	73.139	.0001	73.146	13
48	.01396	.99990	.01396	71.615	.0001	71.622	12
49	.01425	.99990	.01425	70.153	.0001	70.160	11
50	0.01454	0.99989	0.01454	68.750	1.0001	68.757	10
51	.01483	.99989	.01484	67.402	.0001	67.409	9
52	.01512	.99988	.01513	66.105	.0001	66.113	8
53	.01542	.99988	.01542	64.858	.0001	64.866	7
54	.01571	.99988	.01571	63.657	.0001	63.664	6
55	0.01600	0.99987	0.01600	62.499	1.0001	62.507	5
56	.01629	.99987	.01629	61.383	.0001	61.391	4
57	.01658	.99987	.01658	60.306	.0001	60.314	3
58	.01687	.99986	.01687	59.266	.0001	59.274	2
59	.01716	.99985	.01716	58.261	.0001	58.270	1
60	0.01745	0.99985	0.01745	57.290	1.0001	57.299	0
M	Cosine	Sine	Cotan.	Tan.	Cosec.	Secant	M

1° Natural Trigonometric Functions

M	Sine	Cosine	Tan.	Cotan.	Secant	Cosec.	M
0	0.01745	0.99985	0.01745	57 290	1.0001	57.299	60
1	.01774	.99984	.01775	56 350	.0001	56.359	59
2	.01803	.99984	.01804	55 441	.0001	55.450	58
3	.01832	.99983	.01833	54 561	.0002	54.570	57
4	.01861	.99983	.01862	53 708	.0002	53.718	56
5	0.01891	0.99982	0.01891	52 882	1.0002	52.891	55
6	.01920	.99981	.01920	52 081	.0002	52.090	54
7	.01949	.99981	.01949	51 303	.0002	51.313	53
8	.01978	.99980	.01978	50 548	.0002	50.558	52
9	.02007	.99980	.02007	49 816	.0002	49.826	51
10	0.02036	0.99979	0.02036	49 104	1.0002	49.114	50
11	.02065	.99979	.02066	48 412	.0002	48.422	49
12	.02094	.99978	.02095	47 739	.0002	47.750	48
13	.02123	.99977	.02124	47 085	.0002	47.096	47
14	.02152	.99977	.02153	46 449	.0002	46.460	46
15	0.02181	0.99976	0.02182	45 829	1.0002	45.840	45
16	.02210	.99975	.02211	45 226	.0002	45.237	44
17	.02240	.99975	.02240	44 638	.0002	44.650	43
18	.02269	.99974	.02269	44 066	.0002	44.077	42
19	.02298	.99974	.02298	43 508	.0003	43.520	41
20	0.02326	0.99973	0.02327	42 964	1.0003	42.976	40
21	.02356	.99972	.02357	42 433	.0003	42.445	39
22	.02385	.99971	.02386	41 916	.0003	41.928	38
23	.02414	.99971	.02415	41 410	.0003	41.423	37
24	.02443	.99970	.02444	40 917	.0003	40.930	36
25	0.02472	0.99969	0.02473	40 436	1.0003	40.448	35
26	.02501	.99969	.02502	39 965	.0003	39.978	34
27	.02530	.99968	.02531	39 506	.0003	39.518	33
28	.02559	.99967	.02560	39 057	.0003	39.069	32
29	.02589	.99966	.02589	38 618	.0003	38.631	31
30	0.02618	0.99966	0.02618	38 188	1.0003	38.201	30
31	.02647	.99965	.02648	37 769	.0003	37.782	29
32	.02676	.99964	.02677	37 358	.0003	37.371	28
33	.02705	.99963	.02706	36 956	.0004	36.969	27
34	.02734	.99963	.02735	36 563	.0004	36.576	26
35	0.02763	0.99962	0.02764	36 177	1.0004	36.191	25
36	.02792	.99961	.02793	35 800	.0004	35.814	24
37	.02821	.99960	.02822	35 431	.0004	35.445	23
38	.02850	.99959	.02851	35 069	.0004	35.084	22
39	.02879	.99958	.02881	34 715	.0004	34.729	21
40	0.02908	0.99958	0.02910	34 368	1.0004	34.382	20
41	.02937	.99957	.02939	34 027	.0004	34.042	19
42	.02967	.99956	.02963	33 693	.0004	33.708	18
43	.02996	.99955	.02997	33 366	.0004	33.381	17
44	.03025	.99954	.03026	33 045	.0004	33.060	16
45	0.03054	0.99953	0.03055	32 730	1.0005	32.745	15
46	.03083	.99952	.03084	32 421	.0005	32.437	14
47	.03112	.99951	.03113	32 118	.0005	32.134	13
48	.03141	.99951	.03143	31 820	.0005	31.836	12
49	.03170	.99950	.03172	31 528	.0005	31.544	11
50	0.03199	0.99949	0.03201	31 241	1.0005	31.257	10
51	.03228	.99948	.03230	30 960	.0005	30.976	9
52	.03257	.99947	.03259	30 683	.0005	30.699	8
53	.03286	.99946	.03288	30 411	.0005	30.428	7
54	.03315	.99945	.03317	30 145	.0005	30.161	6
55	0.03344	0.99944	0.03346	29 882	1.0005	29.899	5
56	.03374	.99943	.03375	29 624	.0006	29.641	4
57	.03403	.99942	.03405	29 371	.0006	29.388	3
58	.03432	.99941	.03434	29 122	.0006	29.139	2
59	.03461	.99940	.03463	28 877	.0006	28.894	1
60	0.03490	0.99939	0.03492	28 636	1.0006	28.654	0
M	Cosine	Sine	Cotan.	Tan.	Cosec.	Secant	M

M	Sine	Cosine	Tan.	Cotan.	Secant	Cosec.	M
0	0.03490	0.99939	0.03492	28.636	1.0006	28.654	60
1	.03519	.99938	.03521	28.399	.0006	28.417	59
2	.03548	.99937	.03550	28.166	.0006	28.184	58
3	.03577	.99936	.03579	27.937	.0006	27.955	57
4	.03606	.99935	.03608	27.712	.0006	27.730	56
5	0.03635	0.99934	0.03638	27.490	1.0007	27.508	55
6	.03664	.99933	.03667	27.271	.0007	27.290	54
7	.03693	.99932	.03696	27.056	.0007	27.075	53
8	.03722	.99931	.03725	26.845	.0007	26.864	52
9	.03751	.99930	.03754	26.637	.0007	26.655	51
10	0.03781	0.99928	0.03783	26.432	1.0007	26.450	50
11	.03810	.99927	.03812	26.230	.0007	26.249	49
12	.03839	.99926	.03842	26.031	.0007	26.050	48
13	.03868	.99925	.03871	25.835	.0007	25.854	47
14	.03897	.99924	.03900	25.642	.0008	25.661	46
15	0.03926	0.99923	0.03929	25.452	1.0008	25.471	45
16	.03955	.99922	.03958	25.264	.0008	25.284	44
17	.03984	.99921	.03987	25.080	.0008	25.100	43
18	.04013	.99919	.04016	24.898	.0008	24.918	42
19	.04042	.99918	.04045	24.718	.0008	24.739	41
20	0.04071	0.99917	0.04075	24.542	1.0008	24.562	40
21	.04100	.99916	.04104	24.367	.0008	24.388	39
22	.04129	.99915	.04133	24.196	.0008	24.216	38
23	.04158	.99913	.04162	24.026	.0009	24.047	37
24	.04187	.99912	.04191	23.859	.0009	23.880	36
25	0.04217	0.99911	0.04220	23.694	1.0009	23.716	35
26	.04246	.99910	.04249	23.532	.0009	23.553	34
27	.04275	.99908	.04279	23.372	.0009	23.393	33
28	.04304	.99907	.04308	23.214	.0009	23.235	32
29	.04333	.99906	.04337	23.058	.0009	23.079	31
30	0.04362	0.99905	0.04366	22.904	1.0009	22.925	30
31	.04391	.99903	.04395	22.752	.0010	22.774	29
32	.04420	.99902	.04424	22.602	.0010	22.624	28
33	.04449	.99901	.04453	22.454	.0010	22.476	27
34	.04478	.99900	.04483	22.308	.0010	22.330	26
35	0.04507	0.99898	0.04512	22.164	1.0010	22.186	25
36	.04536	.99897	.04541	22.022	.0010	22.044	24
37	.04565	.99896	.04570	21.881	.0010	21.904	23
38	.04594	.99894	.04599	21.742	.0010	21.765	22
39	.04623	.99893	.04628	21.606	.0011	21.629	21
40	0.04652	0.99892	0.04657	21.470	1.0011	21.494	20
41	.04681	.99890	.04687	21.337	.0011	21.360	19
42	.04711	.99889	.04716	21.205	.0011	21.228	18
43	.04740	.99888	.04745	21.075	.0011	21.098	17
44	.04769	.99886	.04774	20.946	.0011	20.970	16
45	0.04798	0.99885	0.04803	20.819	1.0011	20.843	15
46	.04827	.99883	.04832	20.693	.0012	20.717	14
47	.04856	.99882	.04862	20.569	.0012	20.593	13
48	.04885	.99881	.04891	20.446	.0012	20.471	12
49	.04914	.99879	.04920	20.325	.0012	20.350	11
50	0.04943	0.99878	0.04949	20.205	1.0012	20.230	10
51	.04972	.99876	.04978	20.087	.0012	20.112	9
52	.05001	.99875	.05007	19.970	.0012	19.995	8
53	.05030	.99873	.05037	19.854	.0013	19.880	7
54	.05059	.99872	.05066	19.740	.0013	19.766	6
55	0.05088	0.99870	0.05095	19.627	1.0013	19.653	5
56	.05117	.99869	.05124	19.515	.0013	19.541	4
57	.05146	.99867	.05153	19.405	.0013	19.431	3
58	.05175	.99866	.05182	19.296	.0013	19.322	2
59	.05204	.99864	.05212	19.188	.0013	19.214	1
60	0.05234	0.99863	0.05241	19.081	1.0014	19.107	0
M	Cosine	Sine	Cotan.	Tan.	Cosec.	Secant	M

3°

## Natural Trigonometric Functions

M	Sine	Cosine	Tan.	Cotan.	Secant	Cosec.	M
0	0.05234	0.99863	0.05241	19.081	1.0014	19.107	60
1	.05263	.99861	.05270	18.975	.0014	19.002	59
2	.05292	.99860	.05299	18.871	.0014	18.897	58
3	.05321	.99858	.05328	18.768	.0014	18.794	57
4	.05350	.99857	.05357	18.665	.0014	18.692	56
5	0.05379	0.99855	0.05387	18.564	1.0014	18.591	55
6	.05408	.99854	.05416	18.464	.0015	18.491	54
7	.05437	.99852	.05445	18.365	.0015	18.393	53
8	.05466	.99850	.05474	18.268	.0015	18.295	52
9	.05495	.99849	.05503	18.171	.0015	18.198	51
10	0.05524	0.99847	0.05532	18.075	1.0015	18.103	50
11	.05553	.99846	.05562	17.980	.0015	18.008	49
12	.05582	.99844	.05591	17.886	.0016	17.914	48
13	.05611	.99842	.05620	17.793	.0016	17.821	47
14	.05640	.99841	.05649	17.701	.0016	17.730	46
15	0.05669	0.99839	0.05678	17.610	1.0016	17.639	45
16	.05698	.99837	.05707	17.520	.0016	17.549	44
17	.05727	.99836	.05737	17.431	.0016	17.460	43
18	.05756	.99834	.05766	17.343	.0017	17.372	42
19	.05785	.99832	.05795	17.256	.0017	17.285	41
20	0.05814	0.99831	0.05824	17.169	1.0017	17.198	40
21	.05843	.99829	.05853	17.084	.0017	17.113	39
22	.05872	.99827	.05883	16.999	.0017	17.028	38
23	.05902	.99826	.05912	16.915	.0017	16.944	37
24	.05931	.99824	.05941	16.832	.0018	16.861	36
25	0.05960	0.99822	0.05970	16.750	1.0018	16.779	35
26	.05989	.99820	.05999	16.668	.0018	16.698	34
27	.06018	.99819	.06029	16.587	.0018	16.617	33
28	.06047	.99817	.06058	16.507	.0018	16.538	32
29	.06076	.99815	.06087	16.428	.0018	16.459	31
30	0.06105	0.99813	0.06116	16.350	1.0019	16.380	30
31	.06134	.99812	.06145	16.272	.0019	16.303	29
32	.06163	.99810	.06175	16.195	.0019	16.226	28
33	.06192	.99808	.06204	16.119	.0019	16.150	27
34	.06221	.99806	.06233	16.043	.0019	16.075	26
35	0.06250	0.99804	0.06262	15.969	1.0019	16.000	25
36	.06279	.99803	.06291	15.894	.0020	15.926	24
37	.06308	.99801	.06321	15.821	.0020	15.853	23
38	.06337	.99799	.06350	15.748	.0020	15.780	22
39	.06366	.99797	.06379	15.676	.0020	15.708	21
40	0.06395	0.99795	0.06408	15.605	1.0020	15.637	20
41	.06424	.99793	.06437	15.534	.0021	15.566	19
42	.06453	.99791	.06467	15.464	.0021	15.496	18
43	.06482	.99790	.06496	15.394	.0021	15.427	17
44	.06511	.99788	.06525	15.325	.0021	15.358	16
45	0.06540	0.99786	0.06554	15.257	1.0021	15.290	15
46	.06569	.99784	.06583	15.189	.0022	15.222	14
47	.06598	.99782	.06613	15.122	.0022	15.155	13
48	.06627	.99780	.06642	15.056	.0022	15.089	12
49	.06656	.99778	.06671	14.990	.0022	15.023	11
50	0.06685	0.99776	0.06700	14.924	1.0022	14.958	10
51	.06714	.99774	.06730	14.860	.0023	14.893	9
52	.06743	.99772	.06759	14.795	.0023	14.829	8
53	.06772	.99770	.06788	14.732	.0023	14.765	7
54	.06801	.99768	.06817	14.668	.0023	14.702	6
55	0.06830	0.99766	0.06846	14.606	1.0023	14.640	5
56	.06859	.99764	.06876	14.544	.0024	14.578	4
57	.06888	.99762	.06905	14.482	.0024	14.517	3
58	.06918	.99760	.06934	14.421	.0024	14.456	2
59	.06947	.99758	.06963	14.361	.0024	14.395	1
60	0.06976	0.99756	0.06993	14.301	1.0024	14.335	0
M	Cosine	Sine	Cotan.	Tan.	Cosec.	Secant	M

86°

M	Sine	Cosine	Tan.	Cotan.	Secant	Cosec.	M
0	0.06976	0.99756	0.06993	14.301	1.0024	14.335	60
1	.07005	.99754	.07022	14.241	.0025	14.276	59
2	.07034	.99752	.07051	14.182	.0025	14.217	58
3	.07063	.99750	.07080	14.123	.0025	14.159	57
4	.07092	.99748	.07110	14.065	.0025	14.101	56
5	0.07121	0.99746	0.07139	14.008	1.0025	14.043	55
6	.07150	.99744	.07168	13.951	.0026	13.986	54
7	.07179	.99742	.07197	13.894	.0026	13.930	53
8	.07208	.99740	.07226	13.838	.0026	13.874	52
9	.07237	.99738	.07256	13.782	.0026	13.818	51
10	0.07266	0.99736	0.07285	13.727	1.0026	13.763	50
11	.07295	.99733	.07314	13.672	.0027	13.708	49
12	.07324	.99731	.07343	13.617	.0027	13.654	48
13	.07353	.99729	.07373	13.563	.0027	13.600	47
14	.07382	.99727	.07402	13.510	.0027	13.547	46
15	0.07411	0.99725	0.07431	13.457	1.0027	13.494	45
16	.07440	.99723	.07460	13.404	.0028	13.441	44
17	.07469	.99721	.07490	13.351	.0028	13.389	43
18	.07498	.99718	.07519	13.299	.0028	13.337	42
19	.07527	.99716	.07548	13.248	.0028	13.286	41
20	0.07556	0.99714	0.07577	13.197	1.0029	13.235	40
21	.07585	.99712	.07607	13.146	.0029	13.184	39
22	.07614	.99710	.07636	13.096	.0029	13.134	38
23	.07643	.99707	.07665	13.046	.0029	13.084	37
24	.07672	.99705	.07694	12.996	.0029	13.034	36
25	0.07701	0.99703	0.07724	12.947	1.0030	12.985	35
26	.07730	.99701	.07753	12.898	.0030	12.937	34
27	.07759	.99698	.07782	12.849	.0030	12.888	33
28	.07788	.99696	.07812	12.801	.0030	12.840	32
29	.07817	.99694	.07841	12.754	.0031	12.793	31
30	0.07846	0.99692	0.07870	12.706	1.0031	12.745	30
31	.07875	.99689	.07899	12.659	.0031	12.698	29
32	.07904	.99687	.07929	12.612	.0031	12.652	28
33	.07933	.99685	.07958	12.566	.0032	12.606	27
34	.07962	.99682	.07987	12.520	.0032	12.560	26
35	0.07991	0.99680	0.08016	12.474	1.0032	12.514	25
36	.08020	.99678	.08046	12.429	.0032	12.469	24
37	.08049	.99675	.08075	12.384	.0032	12.424	23
38	.08078	.99673	.08104	12.339	.0033	12.379	22
39	.08107	.99671	.08134	12.295	.0033	12.335	21
40	0.08136	0.99668	0.08163	12.250	1.0033	12.291	20
41	.08165	.99666	.08192	12.207	.0033	12.248	19
42	.08194	.99664	.08221	12.163	.0034	12.204	18
43	.08223	.99661	.08251	12.120	.0034	12.161	17
44	.08252	.99659	.08280	12.077	.0034	12.118	16
45	0.08281	0.99656	0.08309	12.035	1.0034	12.076	15
46	.08310	.99654	.08339	11.992	.0035	12.034	14
47	.08339	.99652	.08368	11.950	.0035	11.992	13
48	.08368	.99649	.08397	11.909	.0035	11.950	12
49	.08397	.99647	.08426	11.867	.0035	11.909	11
50	0.08426	0.99644	0.08456	11.826	1.0036	11.868	10
51	.08455	.99642	.08485	11.785	.0036	11.828	9
52	.08484	.99639	.08514	11.745	.0036	11.787	8
53	.08513	.99637	.08544	11.704	.0036	11.747	7
54	.08542	.99634	.08573	11.664	.0037	11.707	6
55	0.08571	0.99632	0.08602	11.625	1.0037	11.668	5
56	.08600	.99629	.08632	11.585	.0037	11.628	4
57	.08629	.99627	.08661	11.546	.0037	11.589	3
58	.08658	.99624	.08690	11.507	.0038	11.550	2
59	.08687	.99622	.08719	11.468	.0038	11.512	1
60	0.08715	0.99619	0.08749	11.430	1.0038	11.474	0
M	Cosine	Sine	Cotan.	Tan.	Cosec.	Secant	M



# 5° Natural Trigonometric Functions

M	Sine	Cosine	Tan.	Cotan.	Secant	Cosec.	M
0	0.08715	0.99619	0.08749	11.430	1.0038	11.474	60
1	.08744	.99617	.08778	11.392	.0038	11.436	59
2	.08773	.99614	.08807	11.354	.0039	11.398	58
3	.08802	.99612	.08837	11.316	.0039	11.360	57
4	.08831	.99609	.08866	11.279	.0039	11.323	56
5	0.08860	0.99607	0.08895	11.242	1.0039	11.286	55
6	.08889	.99604	.08925	11.205	.0040	11.249	54
7	.08918	.99601	.08954	11.168	.0040	11.213	53
8	.08947	.99599	.08983	11.132	.0040	11.176	52
9	.08976	.99596	.09013	11.095	.0040	11.140	51
10	0.09005	0.99594	0.09042	11.059	1.0041	11.104	50
11	.09034	.99591	.09071	11.024	.0041	11.069	49
12	.09063	.99588	.09101	10.988	.0041	11.033	48
13	.09092	.99586	.09130	10.953	.0041	10.998	47
14	.09121	.99583	.09159	10.918	.0042	10.963	46
15	0.09150	0.99580	0.09189	10.883	1.0042	10.929	45
16	.09179	.99578	.09218	10.848	.0042	10.894	44
17	.09208	.99575	.09247	10.814	.0043	10.860	43
18	.09237	.99572	.09277	10.780	.0043	10.826	42
19	.09266	.99570	.09306	10.746	.0043	10.792	41
20	0.09295	0.99567	0.09335	10.712	1.0043	10.758	40
21	.09324	.99564	.09365	10.678	.0044	10.725	39
22	.09353	.99562	.09394	10.645	.0044	10.692	38
23	.09382	.99559	.09423	10.612	.0044	10.659	37
24	.09411	.99556	.09453	10.579	.0044	10.626	36
25	0.09440	0.99553	0.09482	10.546	1.0045	10.593	35
26	.09469	.99551	.09511	10.514	.0045	10.561	34
27	.09498	.99548	.09541	10.481	.0045	10.529	33
28	.09527	.99545	.09570	10.449	.0046	10.497	32
29	.09556	.99542	.09599	10.417	.0046	10.465	31
30	0.09584	0.99540	0.09629	10.385	1.0046	10.433	30
31	.09613	.99537	.09658	10.354	.0046	10.402	29
32	.09642	.99534	.09688	10.322	.0047	10.371	28
33	.09671	.99531	.09717	10.291	.0047	10.340	27
34	.09700	.99528	.09746	10.260	.0047	10.309	26
35	0.09729	0.99525	0.09776	10.229	1.0048	10.278	25
36	.09758	.99523	.09805	10.199	.0048	10.248	24
37	.09787	.99520	.09834	10.168	.0048	10.217	23
38	.09816	.99517	.09864	10.138	.0048	10.187	22
39	.09845	.99514	.09893	10.108	.0049	10.157	21
40	0.09874	0.99511	0.09922	10.078	1.0049	10.127	20
41	.09903	.99508	.09952	10.048	.0049	10.098	19
42	.09932	.99505	.09981	10.019	.0050	10.068	18
43	.09961	.99503	.10011	9.9893	.0050	10.039	17
44	.09990	.99500	.10040	9.9601	.0050	10.010	16
45	0.10019	0.99497	0.10069	9.9310	1.0050	9.9812	15
46	.10048	.99494	.10099	9.9021	.0051	9.9525	14
47	.10077	.99491	.10128	9.8734	.0051	9.9239	13
48	.10106	.99488	.10158	9.8448	.0051	9.8955	12
49	.10134	.99485	.10187	9.8164	.0052	9.8672	11
50	0.10163	0.99482	0.10216	9.7882	1.0052	9.8391	10
51	.10192	.99479	.10246	9.7601	.0052	9.8112	9
52	.10221	.99476	.10275	9.7322	.0053	9.7834	8
53	.10250	.99473	.10305	9.7044	.0053	9.7558	7
54	.10279	.99470	.10334	9.6768	.0053	9.7283	6
55	0.10308	0.99467	0.10363	9.6493	1.0053	9.7010	5
56	.10337	.99464	.10393	9.6220	.0054	9.6739	4
57	.10366	.99461	.10422	9.5949	.0054	9.6469	3
58	.10395	.99458	.10452	9.5679	.0054	9.6200	2
59	.10424	.99455	.10481	9.5411	.0055	9.5933	1
60	0.10453	0.99452	0.10510	9.5144	1.0055	9.5668	0
M	Cosine	Sine	Cotan.	Tan.	Cosec.	Secant	M

# 6° Natural Trigonometric Functions

M	Sine	Cosine	Tan.	Cotan.	Secant	Cosec.	M
0	0.10453	0.99452	0.10510	9.5144	1.0055	9.5663	60
1	.10482	.99449	.10540	.4878	.0055	.5404	59
2	.10511	.99446	.10569	.4614	.0056	.5141	58
3	.10540	.99443	.10599	.4351	.0056	.4880	57
4	.10568	.99440	.10628	.4090	.0056	.4620	56
5	0.10597	0.99437	0.10657	9.3831	1.0057	9.4362	55
6	.10626	.99434	.10687	.3572	.0057	.4105	54
7	.10655	.99431	.10716	.3315	.0057	.3850	53
8	.10684	.99428	.10746	.3060	.0057	.3596	52
9	.10713	.99424	.10775	.2806	.0058	.3343	51
10	0.10742	0.99421	0.10805	9.2553	1.0058	9.3092	50
11	.10771	.99418	.10834	.2302	.0058	.2842	49
12	.10800	.99415	.10863	.2051	.0059	.2593	48
13	.10829	.99412	.10893	.1803	.0059	.2346	47
14	.10858	.99409	.10922	.1555	.0059	.2100	46
15	0.10887	0.99406	0.10952	9.1309	1.0060	9.1855	45
16	.10916	.99402	.10981	.1064	.0060	.1612	44
17	.10944	.99399	.11011	.0821	.0060	.1370	43
18	.10973	.99396	.11040	.0579	.0061	.1129	42
19	.11002	.99393	.11069	.0338	.0061	.0890	41
20	0.11031	0.99390	0.11099	9.0098	1.0061	9.0651	40
21	.11060	.99386	.11128	8.9860	.0062	.0414	39
22	.11089	.99383	.11158	.9623	.0062	.0179	38
23	.11118	.99380	.11187	.9387	.0062	8.9944	37
24	.11147	.99377	.11217	.9152	.0063	.9711	36
25	0.11176	0.99373	0.11246	8.8918	1.0063	8.9479	35
26	.11205	.99370	.11276	.8686	.0063	.9248	34
27	.11234	.99367	.11305	.8455	.0064	.9018	33
28	.11262	.99364	.11335	.8225	.0064	.8790	32
29	.11291	.99360	.11364	.7996	.0064	.8563	31
30	0.11320	0.99357	0.11393	8.7769	1.0065	8.8337	30
31	.11349	.99354	.11423	.7542	.0065	.8112	29
32	.11378	.99350	.11452	.7317	.0065	.7888	28
33	.11407	.99347	.11482	.7093	.0066	.7665	27
34	.11436	.99344	.11511	.6870	.0066	.7444	26
35	0.11465	0.99341	0.11541	8.6648	1.0066	8.7223	25
36	.11494	.99337	.11570	.6427	.0067	.7004	24
37	.11523	.99334	.11600	.6208	.0067	.6786	23
38	.11551	.99330	.11629	.5989	.0067	.6569	22
39	.11580	.99327	.11659	.5772	.0068	.6353	21
40	0.11609	0.99324	0.11688	8.5555	1.0068	8.6138	20
41	.11638	.99320	.11718	.5340	.0068	.5924	19
42	.11667	.99317	.11747	.5126	.0069	.5711	18
43	.11696	.99314	.11777	.4913	.0069	.5499	17
44	.11725	.99310	.11806	.4701	.0069	.5289	16
45	0.11754	0.99307	0.11836	8.4489	1.0070	8.5079	15
46	.11783	.99303	.11865	.4279	.0070	.4871	14
47	.11811	.99300	.11895	.4070	.0070	.4663	13
48	.11840	.99296	.11924	.3862	.0071	.4457	12
49	.11869	.99293	.11954	.3655	.0071	.4251	11
50	0.11898	0.99290	0.11983	8.3449	1.0071	8.4046	10
51	.11927	.99286	.12013	.3244	.0072	.3843	9
52	.11956	.99283	.12042	.3040	.0072	.3640	8
53	.11985	.99279	.12072	.2837	.0073	.3439	7
54	.12014	.99276	.12101	.2635	.0073	.3238	6
55	0.12042	0.99272	0.12131	8.2434	1.0073	8.3039	5
56	.12071	.99269	.12160	.2234	.0074	.2840	4
57	.12100	.99265	.12190	.2035	.0074	.2642	3
58	.12129	.99262	.12219	.1837	.0074	.2446	2
59	.12158	.99258	.12249	.1640	.0075	.2250	1
60	0.12187	0.99255	0.12278	8.1443	1.0075	8.2055	0

M	Cosine	Sine	Cotan.	Tan.	Cosec.	Secant	M
---	--------	------	--------	------	--------	--------	---

7° Natural Trigonometric Functions

M	Sine	Cosine	Tan.	Cotan.	Secant	Cosec.	M
0	0.12187	0.99255	0.12278	8.1443	1.0075	8.2055	60
1	.12216	.99251	.12308	.1248	.0075	.1861	59
2	.12245	.99247	.12337	.1053	.0076	.1668	58
3	.12273	.99244	.12367	.0860	.0076	.1476	57
4	.12302	.99240	.12396	.0667	.0076	.1285	56
5	0.12331	0.99237	0.12426	8.0476	1.0077	8.1094	55
6	.12360	.99233	.12456	.0285	.0077	.0905	54
7	.12389	.99229	.12485	.0095	.0078	.0717	53
8	.12418	.99226	.12515	7.9906	.0078	.0529	52
9	.12447	.99222	.12544	.9717	.0078	.0342	51
10	0.12476	0.99219	0.12574	7.9530	1.0079	8.0156	50
11	.12504	.99215	.12603	.9344	.0079	7.9971	49
12	.12533	.99211	.12633	.9158	.0079	.9787	48
13	.12562	.99208	.12662	.8973	.0080	.9604	47
14	.12591	.99204	.12692	.8789	.0080	.9421	46
15	0.12620	0.99200	0.12722	7.8606	1.0080	7.9240	45
16	.12649	.99197	.12751	.8424	.0081	.9059	44
17	.12678	.99193	.12781	.8243	.0081	.8879	43
18	.12706	.99189	.12810	.8062	.0082	.8700	42
19	.12735	.99186	.12840	.7882	.0082	.8522	41
20	0.12764	0.99182	0.12869	7.7703	1.0082	7.8344	40
21	.12793	.99178	.12899	.7525	.0083	.8168	39
22	.12822	.99174	.12928	.7348	.0083	.7992	38
23	.12851	.99171	.12958	.7171	.0084	.7817	37
24	.12879	.99167	.12988	.6996	.0084	.7642	36
25	0.12908	0.99163	0.13017	7.6821	1.0084	7.7469	35
26	.12937	.99160	.13047	.6646	.0085	.7296	34
27	.12966	.99156	.13076	.6473	.0085	.7124	33
28	.12995	.99152	.13106	.6300	.0085	.6953	32
29	.13024	.99148	.13136	.6129	.0086	.6783	31
30	0.13053	0.99144	0.13165	7.5957	1.0086	7.6613	30
31	.13081	.99141	.13195	.5787	.0087	.6444	29
32	.13110	.99137	.13224	.5617	.0087	.6276	28
33	.13139	.99133	.13254	.5449	.0087	.6108	27
34	.13168	.99129	.13284	.5280	.0088	.5942	26
35	0.13197	0.99125	0.13313	7.5113	1.0088	7.5776	25
36	.13226	.99121	.13343	.4946	.0089	.5611	24
37	.13254	.99118	.13372	.4780	.0089	.5446	23
38	.13283	.99114	.13402	.4615	.0089	.5282	22
39	.13312	.99110	.13432	.4451	.0090	.5119	21
40	0.13341	0.99106	0.13461	7.4287	1.0090	7.4957	20
41	.13370	.99102	.13491	.4124	.0090	.4795	19
42	.13399	.99098	.13520	.3961	.0091	.4634	18
43	.13427	.99094	.13550	.3800	.0091	.4474	17
44	.13456	.99090	.13580	.3639	.0092	.4315	16
45	0.13485	0.99086	0.13609	7.3479	1.0092	7.4156	15
46	.13514	.99083	.13639	.3319	.0092	.3998	14
47	.13543	.99079	.13669	.3160	.0093	.3840	13
48	.13571	.99075	.13698	.3002	.0093	.3683	12
49	.13600	.99071	.13728	.2844	.0094	.3527	11
50	0.13629	0.99067	0.13757	7.2687	1.0094	7.3372	10
51	.13658	.99063	.13787	.2531	.0094	.3217	9
52	.13687	.99059	.13817	.2375	.0095	.3063	8
53	.13716	.99055	.13846	.2220	.0095	.2909	7
54	.13744	.99051	.13876	.2066	.0096	.2757	6
55	0.13773	0.99047	0.13906	7.1912	1.0096	7.2604	5
56	.13802	.99043	.13935	.1759	.0097	.2453	4
57	.13831	.99039	.13965	.1607	.0097	.2302	3
58	.13860	.99035	.13995	.1455	.0097	.2152	2
59	.13888	.99031	.14024	.1304	.0098	.2002	1
60	0.13917	0.99027	0.14054	7.1154	1.0098	7.1853	0
M	Cosine	Sine	Cotan.	Tan.	Cosec.	Secant	M

8° Natural Trigonometric Functions

M	Sine	Cosine	Tan.	Cotan.	Secant	Cosec.	M
0	0.13917	0.99027	0.14054	7.1154	1.0098	7.1853	60
1	.13946	.99023	.14084	.1004	.0099	.1704	59
2	.13975	.99019	.14113	.0854	.0099	.1557	58
3	.14004	.99015	.14143	.0706	.0099	.1409	57
4	.14032	.99010	.14173	.0558	.0100	.1263	56
5	0.14061	0.99006	0.14202	7.0410	1.0100	7.1117	55
6	.14090	.99002	.14232	.0264	.0101	.0972	54
7	.14119	.98998	.14262	.0117	.0101	.0827	53
8	.14148	.98994	.14291	6.9972	.0102	.0683	52
9	.14176	.98990	.14321	.9827	.0102	.0539	51
10	0.14205	0.98986	0.14351	6.9682	1.0102	7.0396	50
11	.14234	.98982	.14380	.9538	.0103	.0254	49
12	.14263	.98978	.14410	.9395	.0103	.0112	48
13	.14292	.98973	.14440	.9252	.0104	6.9971	47
14	.14320	.98969	.14470	.9110	.0104	.9330	46
15	0.14349	0.98965	0.14499	6.8969	1.0104	6.9690	45
16	.14378	.98961	.14529	.8828	.0105	.9550	44
17	.14407	.98957	.14559	.8687	.0105	.9411	43
18	.14436	.98952	.14588	.8547	.0106	.9273	42
19	.14464	.98948	.14618	.8408	.0106	.9135	41
20	0.14493	0.98944	0.14648	6.8269	1.0107	6.8998	40
21	.14522	.98940	.14677	.8131	.0107	.8861	39
22	.14551	.98936	.14707	.7993	.0107	.8725	38
23	.14579	.98931	.14737	.7856	.0108	.8589	37
24	.14608	.98927	.14767	.7720	.0108	.8454	36
25	0.14637	0.98923	0.14796	6.7584	1.0109	6.8320	35
26	.14666	.98919	.14826	.7448	.0109	.8185	34
27	.14695	.98914	.14856	.7313	.0110	.8052	33
28	.14723	.98910	.14886	.7179	.0110	.7919	32
29	.14752	.98906	.14915	.7045	.0111	.7787	31
30	0.14781	0.98901	0.14945	6.6911	1.0111	6.7655	30
31	.14810	.98897	.14975	.6779	.0111	.7523	29
32	.14838	.98893	.15004	.6646	.0112	.7392	28
33	.14867	.98889	.15034	.6514	.0112	.7262	27
34	.14896	.98884	.15064	.6383	.0113	.7132	26
35	0.14925	0.98880	0.15094	6.6252	1.0113	6.7003	25
36	.14953	.98876	.15123	.6122	.0114	.6874	24
37	.14982	.98871	.15153	.5992	.0114	.6745	23
38	.15011	.98867	.15183	.5863	.0115	.6617	22
39	.15040	.98862	.15213	.5734	.0115	.6490	21
40	0.15068	0.98858	0.15243	6.5605	1.0115	6.6363	20
41	.15097	.98854	.15272	.5478	.0116	.6237	19
42	.15126	.98849	.15302	.5350	.0116	.6111	18
43	.15155	.98845	.15332	.5223	.0117	.5985	17
44	.15183	.98840	.15362	.5097	.0117	.5860	16
45	0.15212	0.98836	0.15391	6.4971	1.0118	6.5736	15
46	.15241	.98832	.15421	.4845	.0118	.5612	14
47	.15270	.98827	.15451	.4720	.0119	.5488	13
48	.15298	.98823	.15481	.4596	.0119	.5365	12
49	.15328	.98818	.15511	.4472	.0119	.5243	11
50	0.15356	0.98814	0.15540	6.4348	1.0120	6.5121	10
51	.15385	.98809	.15570	.4225	.0120	.4999	9
52	.15413	.98805	.15600	.4103	.0121	.4878	8
53	.15442	.98800	.15630	.3980	.0121	.4757	7
54	.15471	.98796	.15659	.3859	.0122	.4637	6
55	0.15500	0.98791	0.15689	6.3737	1.0122	6.4517	5
56	.15528	.98787	.15719	.3616	.0123	.4398	4
57	.15557	.98782	.15749	.3496	.0123	.4279	3
58	.15586	.98778	.15779	.3376	.0124	.4160	2
59	.15615	.98773	.15809	.3257	.0124	.4042	1
60	0.15643	0.98769	0.15838	6.3137	1.0125	6.3924	0
M	Cosine	Sine	Cotan.	Tan.	Cosec.	Secant	M

9°

## Natural Trigonometric Functions

M	Sine	Cosine	Tan.	Cotan.	Secant	Cosec.	M
0	0.15643	0.98769	0.15838	6.3137	1.0125	6.3924	60
1	.15672	.98764	.15868	.3019	.0125	.3807	59
2	.15701	.98760	.15898	.2901	.0125	.3690	58
3	.15730	.98755	.15928	.2783	.0126	.3574	57
4	.15758	.98750	.15958	.2665	.0126	.3458	56
5	0.15787	0.98746	0.15987	6.2548	1.0127	6.3343	55
6	.15816	.98741	.16017	.2432	.0127	.3228	54
7	.15844	.98737	.16047	.2316	.0128	.3113	53
8	.15873	.98732	.16077	.2200	.0128	.2999	52
9	.15902	.98727	.16107	.2085	.0129	.2885	51
10	0.15931	0.98723	0.16137	6.1970	1.0129	6.2772	50
11	.15959	.98718	.16167	.1856	.0130	.2659	49
12	.15988	.98714	.16196	.1742	.0130	.2546	48
13	.16017	.98709	.16226	.1628	.0131	.2434	47
14	.16045	.98704	.16256	.1515	.0131	.2322	46
15	0.16074	0.98700	0.16286	6.1402	1.0132	6.2211	45
16	.16103	.98695	.16316	.1290	.0132	.2100	44
17	.16132	.98690	.16346	.1178	.0133	.1990	43
18	.16160	.98685	.16376	.1066	.0133	.1880	42
19	.16189	.98681	.16405	.0955	.0134	.1770	41
20	0.16218	0.98676	0.16435	6.0844	1.0134	6.1661	40
21	.16246	.98671	.16465	.0734	.0135	.1552	39
22	.16275	.98667	.16495	.0624	.0135	.1443	38
23	.16304	.98662	.16525	.0514	.0136	.1335	37
24	.16333	.98657	.16555	.0405	.0136	.1227	36
25	0.16361	0.98652	0.16585	6.0296	1.0136	6.1120	35
26	.16390	.98648	.16615	.0188	.0137	.1013	34
27	.16419	.98643	.16644	.0080	.0137	.0906	33
28	.16447	.98638	.16674	5.9972	.0138	.0800	32
29	.16476	.98633	.16704	.9865	.0138	.0694	31
30	0.16505	0.98628	0.16734	5.9758	1.0139	6.0588	30
31	.16533	.98624	.16764	.9651	.0139	.0483	29
32	.16562	.98619	.16794	.9545	.0140	.0379	28
33	.16591	.98614	.16824	.9439	.0140	.0274	27
34	.16619	.98609	.16854	.9333	.0141	.0170	26
35	0.16648	0.98604	0.16884	5.9228	1.0141	6.0066	25
36	.16677	.98600	.16914	.9123	.0142	5.9963	24
37	.16705	.98595	.16944	.9019	.0142	.9860	23
38	.16734	.98590	.16973	.8915	.0143	.9758	22
39	.16763	.98585	.17003	.8811	.0143	.9655	21
40	0.16791	0.98580	0.17033	5.8708	1.0144	5.9554	20
41	.16820	.98575	.17063	.8605	.0144	.9452	19
42	.16849	.98570	.17093	.8502	.0145	.9351	18
43	.16878	.98565	.17123	.8400	.0145	.9250	17
44	.16906	.98560	.17153	.8298	.0146	.9150	16
45	0.16935	0.98556	0.17183	5.8196	1.0146	5.9049	15
46	.16964	.98551	.17213	.8095	.0147	.8950	14
47	.16992	.98546	.17243	.7994	.0147	.8850	13
48	.17021	.98541	.17273	.7894	.0148	.8751	12
49	.17050	.98536	.17303	.7794	.0148	.8652	11
50	0.17078	0.98531	0.17333	5.7694	1.0149	5.8554	10
51	.17107	.98526	.17363	.7594	.0150	.8456	9
52	.17136	.98521	.17393	.7495	.0150	.8358	8
53	.17164	.98516	.17423	.7396	.0151	.8261	7
54	.17193	.98511	.17453	.7297	.0151	.8163	6
55	0.17221	0.98506	0.17483	5.7199	1.0152	5.8067	5
56	.17250	.98501	.17513	.7101	.0152	.7970	4
57	.17279	.98496	.17543	.7004	.0153	.7874	3
58	.17307	.98491	.17573	.6906	.0153	.7778	2
59	.17336	.98486	.17603	.6809	.0154	.7683	1
60	0.17365	0.98481	0.17633	5.6713	1.0154	5.7588	0
M	Cosine	Sine	Cotan.	Tan.	Cosec.	Secant	M

80°

10° Natural Trigonometric Functions

M	Sine	Cosine	Tan.	Cotan.	Secant	Cosec.	M
0	0.17365	0.98481	0.17633	5.6713	1.0154	5.7588	60
1	.17393	.98476	.17663	.6616	.0155	.7493	59
2	.17422	.98471	.17693	.6520	.0155	.7398	58
3	.17451	.98465	.17723	.6425	.0156	.7304	57
4	.17479	.98460	.17753	.6329	.0156	.7210	56
5	0.17508	0.98455	0.17783	5.6234	1.0157	5.7117	55
6	.17537	.98450	.17813	.6140	.0157	.7023	54
7	.17565	.98445	.17843	.6045	.0158	.6930	53
8	.17594	.98440	.17873	.5951	.0158	.6838	52
9	.17622	.98435	.17903	.5857	.0159	.6745	51
10	0.17651	0.98430	0.17933	5.5764	1.0159	5.6653	50
11	.17680	.98425	.17963	.5670	.0160	.6561	49
12	.17708	.98419	.17993	.5578	.0160	.6470	48
13	.17737	.98414	.18023	.5485	.0161	.6379	47
14	.17766	.98409	.18053	.5393	.0162	.6288	46
15	0.17794	0.98404	0.18083	5.5301	1.0162	5.6197	45
16	.17823	.98399	.18113	.5209	.0163	.6107	44
17	.17852	.98394	.18143	.5117	.0163	.6017	43
18	.17880	.98388	.18173	.5026	.0164	.5928	42
19	.17909	.98383	.18203	.4936	.0164	.5838	41
20	0.17937	0.98378	0.18233	5.4845	1.0165	5.5749	40
21	.17966	.98373	.18263	.4755	.0165	.5660	39
22	.17995	.98368	.18293	.4665	.0166	.5572	38
23	.18023	.98362	.18323	.4575	.0166	.5484	37
24	.18052	.98357	.18353	.4486	.0167	.5396	36
25	0.18080	0.98352	0.18383	5.4396	1.0167	5.5308	35
26	.18109	.98347	.18413	.4308	.0168	.5221	34
27	.18138	.98341	.18444	.4219	.0169	.5134	33
28	.18166	.98336	.18474	.4131	.0169	.5047	32
29	.18195	.98331	.18504	.4043	.0170	.4960	31
30	0.18223	0.98325	0.18534	5.3955	1.0170	5.4874	30
31	.18252	.98320	.18564	.3868	.0171	.4788	29
32	.18281	.98315	.18594	.3780	.0171	.4702	28
33	.18309	.98309	.18624	.3694	.0172	.4617	27
34	.18338	.98304	.18654	.3607	.0172	.4532	26
35	0.18366	0.98299	0.18684	5.3521	1.0173	5.4447	25
36	.18395	.98293	.18714	.3434	.0174	.4362	24
37	.18424	.98288	.18745	.3349	.0174	.4278	23
38	.18452	.98283	.18775	.3263	.0175	.4194	22
39	.18481	.98277	.18805	.3178	.0175	.4110	21
40	0.18509	0.98272	0.18835	5.3093	1.0176	5.4026	20
41	.18538	.98267	.18865	.3008	.0176	.3943	19
42	.18567	.98261	.18895	.2923	.0177	.3860	18
43	.18595	.98256	.18925	.2839	.0177	.3777	17
44	.18624	.98250	.18955	.2755	.0178	.3695	16
45	0.18652	0.98245	0.18985	5.2671	1.0179	5.3612	15
46	.18681	.98240	.19016	.2588	.0179	.3530	14
47	.18709	.98234	.19046	.2505	.0180	.3449	13
48	.18738	.98229	.19076	.2422	.0180	.3367	12
49	.18767	.98223	.19106	.2339	.0181	.3286	11
50	0.18795	0.98218	0.19136	5.2257	1.0181	5.3205	10
51	.18824	.98212	.19166	.2174	.0182	.3124	9
52	.18852	.98207	.19197	.2092	.0182	.3044	8
53	.18881	.98201	.19227	.2011	.0183	.2963	7
54	.18909	.98196	.19257	.1929	.0184	.2883	6
55	0.18938	0.98190	0.19287	5.1848	1.0184	5.2803	5
56	.18967	.98185	.19317	.1767	.0185	.2724	4
57	.18995	.98179	.19347	.1686	.0185	.2645	3
58	.19024	.98174	.19378	.1606	.0186	.2566	2
59	.19052	.98168	.19408	.1525	.0186	.2487	1
60	0.19081	0.98163	0.19438	5.1445	1.0187	5.2408	0
M	Cosine	Sine	Cotan.	Tan.	Cosec.	Secant	M

11° Natural Trigonometric Functions

M	Sine	Cosine	Tan.	Cotan.	Secant	Cosec.	M
0	0.19081	0.98163	0.19438	5.1445	1.0187	5.2408	60
1	.19109	.98157	.19468	.1366	.0188	.2330	59
2	.19138	.98152	.19498	.1286	.0188	.2252	58
3	.19166	.98146	.19529	.1207	.0189	.2174	57
4	.19195	.98140	.19559	.1128	.0189	.2097	56
5	0.19224	0.98135	0.19589	5.1049	1.0190	5.2019	55
6	.19252	.98129	.19619	.0970	.0191	.1942	54
7	.19281	.98124	.19649	.0892	.0191	.1865	53
8	.19309	.98118	.19680	.0814	.0192	.1788	52
9	.19338	.98112	.19710	.0736	.0192	.1712	51
10	0.19366	0.98107	0.19740	5.0658	1.0193	5.1636	50
11	.19395	.98101	.19770	.0581	.0193	.1560	49
12	.19423	.98095	.19800	.0504	.0194	.1484	48
13	.19452	.98090	.19831	.0427	.0195	.1409	47
14	.19480	.98084	.19861	.0350	.0195	.1333	46
15	0.19509	0.98078	0.19891	5.0273	1.0196	5.1258	45
16	.19537	.98073	.19921	.0197	.0196	.1183	44
17	.19566	.98067	.19952	.0121	.0197	.1109	43
18	.19595	.98061	.19982	.0045	.0198	.1034	42
19	.19623	.98056	.20012	4.9969	.0198	.0960	41
20	0.19652	0.98050	0.20042	4.9894	1.0199	5.0886	40
21	.19680	.98044	.20073	.9819	.0199	.0812	39
22	.19709	.98039	.20103	.9744	.0200	.0739	38
23	.19737	.98033	.20133	.9669	.0201	.0666	37
24	.19766	.98027	.20163	.9594	.0201	.0593	36
25	0.19794	0.98021	0.20194	4.9520	1.0202	5.0520	35
26	.19823	.98016	.20224	.9446	.0202	.0447	34
27	.19851	.98010	.20254	.9372	.0203	.0375	33
28	.19880	.98004	.20285	.9298	.0204	.0302	32
29	.19908	.97998	.20315	.9225	.0204	.0230	31
30	0.19937	0.97992	0.20345	4.9151	1.0205	5.0158	30
31	.19965	.97987	.20375	.9078	.0205	.0087	29
32	.19994	.97981	.20406	.9006	.0206	.0015	28
33	.20022	.97975	.20436	.8933	.0207	4.9944	27
34	.20051	.97969	.20466	.8860	.0207	.9873	26
35	0.20079	0.97963	0.20497	4.8788	1.0208	4.9802	25
36	.20108	.97957	.20527	.8716	.0208	.9732	24
37	.20136	.97952	.20557	.8644	.0209	.9661	23
38	.20165	.97946	.20588	.8573	.0210	.9591	22
39	.20193	.97940	.20618	.8501	.0210	.9521	21
40	0.20222	0.97934	0.20648	4.8430	1.0211	4.9452	20
41	.20250	.97928	.20679	.8359	.0211	.9382	19
42	.20279	.97922	.20709	.8288	.0212	.9313	18
43	.20307	.97916	.20739	.8217	.0213	.9243	17
44	.20336	.97910	.20770	.8147	.0213	.9175	16
45	0.20364	0.97904	0.20800	4.8077	1.0214	4.9106	15
46	.20393	.97899	.20830	.8007	.0215	.9037	14
47	.20421	.97893	.20861	.7937	.0215	.8969	13
48	.20450	.97887	.20891	.7867	.0216	.8901	12
49	.20478	.97881	.20921	.7798	.0216	.8833	11
50	0.20506	0.97875	0.20952	4.7728	1.0217	4.8765	10
51	.20535	.97869	.20982	.7659	.0218	.8697	9
52	.20563	.97863	.21012	.7591	.0218	.8630	8
53	.20592	.97857	.21043	.7522	.0219	.8563	7
54	.20620	.97851	.21073	.7453	.0220	.8496	6
55	0.20649	0.97845	0.21104	4.7385	1.0220	4.8429	5
56	.20677	.97839	.21134	.7317	.0221	.8362	4
57	.20706	.97833	.21164	.7249	.0221	.8296	3
58	.20734	.97827	.21195	.7181	.0222	.8229	2
59	.20763	.97821	.21225	.7114	.0223	.8163	1
60	0.20791	0.97815	0.21256	4.7046	1.0223	4.8097	0
M	Cosine	Sine	Cotan.	Tan.	Cosec.	Secant	M

# 12° Natural Trigonometric Functions

M	Sine	Cosine	Tan.	Cotan.	Secant	Cosec.	M
0	0.20791	0.97815	0.21256	4.7046	I.0223	4.8097	60
1	.20820	.97809	.21286	.6979	.0224	.8032	59
2	.20848	.97803	.21316	.6912	.0225	.7966	58
3	.20876	.97797	.21347	.6845	.0225	.7901	57
4	.20905	.97790	.21377	.6778	.0226	.7835	56
5	0.20933	0.97784	0.21408	4.6712	I.0226	4.7770	55
6	.20962	.97778	.21438	.6646	.0227	.7706	54
7	.20990	.97772	.21468	.6580	.0228	.7641	53
8	.21019	.97766	.21499	.6514	.0228	.7576	52
9	.21047	.97760	.21529	.6448	.0229	.7512	51
10	0.21076	0.97754	0.21560	4.6382	I.0230	4.7448	50
11	.21104	.97748	.21590	.6317	.0230	.7384	49
12	.21132	.97741	.21621	.6252	.0231	.7320	48
13	.21161	.97735	.21651	.6187	.0232	.7257	47
14	.21189	.97729	.21682	.6122	.0232	.7193	46
15	0.21218	0.97723	0.21712	4.6057	I.0233	4.7130	45
16	.21246	.97717	.21742	.5993	.0234	.7067	44
17	.21275	.97711	.21773	.5928	.0234	.7004	43
18	.21303	.97704	.21803	.5864	.0235	.6942	42
19	.21331	.97698	.21834	.5800	.0235	.6879	41
20	0.21360	0.97692	0.21864	4.5736	I.0236	4.6817	40
21	.21388	.97686	.21895	.5673	.0237	.6754	39
22	.21417	.97680	.21925	.5609	.0237	.6692	38
23	.21445	.97673	.21956	.5546	.0238	.6631	37
24	.21473	.97667	.21986	.5483	.0239	.6569	36
25	0.21502	0.97661	0.22017	4.5420	I.0239	4.6507	35
26	.21530	.97655	.22047	.5357	.0240	.6446	34
27	.21559	.97648	.22078	.5294	.0241	.6385	33
28	.21587	.97642	.22108	.5232	.0241	.6324	32
29	.21615	.97636	.22139	.5169	.0242	.6263	31
30	0.21644	0.97630	0.22169	4.5107	I.0243	4.6201	30
31	.21672	.97623	.22200	.5045	.0243	.6142	29
32	.21701	.97617	.22230	.4983	.0244	.6081	28
33	.21729	.97611	.22261	.4921	.0245	.6021	27
34	.21757	.97604	.22291	.4860	.0245	.5961	26
35	0.21786	0.97598	0.22322	4.4799	I.0246	4.5901	25
36	.21814	.97592	.22353	.4737	.0247	.5841	24
37	.21843	.97585	.22383	.4676	.0247	.5782	23
38	.21871	.97579	.22414	.4615	.0248	.5722	22
39	.21899	.97573	.22444	.4555	.0249	.5663	21
40	0.21928	0.97566	0.22475	4.4494	I.0249	4.5604	20
41	.21956	.97560	.22505	.4434	.0250	.5545	19
42	.21985	.97553	.22536	.4373	.0251	.5486	18
43	.22013	.97547	.22566	.4313	.0251	.5428	17
44	.22041	.97541	.22597	.4253	.0252	.5369	16
45	0.22070	0.97534	0.22628	4.4194	I.0253	4.5311	15
46	.22098	.97528	.22658	.4134	.0253	.5253	14
47	.22126	.97521	.22689	.4074	.0254	.5195	13
48	.22155	.97515	.22719	.4015	.0255	.5137	12
49	.22183	.97508	.22750	.3956	.0255	.5079	11
50	0.22211	0.97502	0.22781	4.3897	I.0256	4.5021	10
51	.22240	.97495	.22811	.3838	.0257	.4964	9
52	.22268	.97489	.22842	.3779	.0257	.4907	8
53	.22297	.97483	.22872	.3721	.0258	.4850	7
54	.22325	.97476	.22903	.3662	.0259	.4793	6
55	0.22353	0.97470	0.22934	4.3604	I.0260	4.4736	5
56	.22382	.97463	.22964	.3546	.0260	.4679	4
57	.22410	.97457	.22995	.3488	.0261	.4623	3
58	.22438	.97450	.23025	.3430	.0262	.4566	2
59	.22467	.97443	.23056	.3372	.0262	.4510	1
60	0.22495	0.97437	0.23087	4.3315	I.0263	4.4454	0
M	Cosine	Sine	Cotan.	Tan.	Cosec.	Secant	M



# 13° Natural Trigonometric Functions

M	Sine	Cosine	Tan.	Cotan.	Secant	Cosec.	M
0	0.22495	0.97437	0.23087	4.3315	I.0263	4.4454	60
1	.22523	.97430	.23117	.3257	.0264	.4398	59
2	.22552	.97424	.23148	.3200	.0264	.4342	58
3	.22580	.97417	.23179	.3143	.0265	.4287	57
4	.22608	.97411	.23209	.3086	.0266	.4231	56
5	0.22637	0.97404	0.23240	4.3029	I.0266	4.4176	55
6	.22665	.97398	.23270	.2972	.0267	.4121	54
7	.22693	.97391	.23301	.2916	.0268	.4065	53
8	.22722	.97384	.23332	.2859	.0268	.4011	52
9	.22750	.97378	.23363	.2803	.0269	.3956	51
10	0.22778	0.97371	0.23393	4.2747	I.0270	4.3901	50
11	.22807	.97364	.23424	.2691	.0271	.3847	49
12	.22835	.97358	.23455	.2635	.0271	.3792	48
13	.22863	.97351	.23485	.2579	.0272	.3738	47
14	.22892	.97344	.23516	.2524	.0273	.3684	46
15	0.22920	0.97338	0.23547	4.2468	I.0273	4.3630	45
16	.22948	.97331	.23577	.2413	.0274	.3576	44
17	.22977	.97324	.23608	.2358	.0275	.3522	43
18	.23005	.97318	.23639	.2303	.0276	.3469	42
19	.23033	.97311	.23670	.2248	.0276	.3415	41
20	0.23061	0.97304	0.23700	4.2193	I.0277	4.3362	40
21	.23090	.97298	.23731	.2139	.0278	.3309	39
22	.23118	.97291	.23762	.2084	.0278	.3256	38
23	.23146	.97284	.23793	.2030	.0279	.3203	37
24	.23175	.97277	.23823	.1976	.0280	.3150	36
25	0.23203	0.97271	0.23854	4.1921	I.0280	4.3098	35
26	.23231	.97264	.23885	.1867	.0281	.3045	34
27	.23260	.97257	.23916	.1814	.0282	.2993	33
28	.23288	.97250	.23946	.1760	.0283	.2941	32
29	.23316	.97244	.23977	.1706	.0283	.2888	31
30	0.23344	0.97237	0.24008	4.1653	I.0284	4.2836	30
31	.23373	.97230	.24039	.1600	.0285	.2785	29
32	.23401	.97223	.24069	.1546	.0285	.2733	28
33	.23429	.97216	.24100	.1493	.0286	.2681	27
34	.23458	.97210	.24131	.1440	.0287	.2630	26
35	0.23486	0.97203	0.24162	4.1388	I.0288	4.2579	25
36	.23514	.97196	.24192	.1335	.0288	.2527	24
37	.23542	.97189	.24223	.1282	.0289	.2476	23
38	.23571	.97182	.24254	.1230	.0290	.2425	22
39	.23599	.97175	.24285	.1178	.0291	.2375	21
40	0.23627	0.97169	0.24316	4.1126	I.0291	4.2324	20
41	.23655	.97162	.24346	.1073	.0292	.2273	19
42	.23684	.97155	.24377	.1022	.0293	.2223	18
43	.23712	.97148	.24408	.0970	.0293	.2173	17
44	.23740	.97141	.24439	.0918	.0294	.2122	16
45	0.23768	0.97134	0.24470	4.0867	I.0295	4.2072	15
46	.23797	.97127	.24501	.0815	.0296	.2022	14
47	.23825	.97120	.24531	.0764	.0296	.1972	13
48	.23853	.97113	.24562	.0713	.0297	.1923	12
49	.23881	.97106	.24593	.0662	.0298	.1873	11
50	0.23910	0.97099	0.24624	4.0611	I.0299	4.1824	10
51	.23938	.97092	.24655	.0560	.0299	.1774	9
52	.23966	.97086	.24686	.0509	.0300	.1725	8
53	.23994	.97079	.24717	.0458	.0301	.1676	7
54	.24023	.97072	.24747	.0408	.0302	.1627	6
55	0.24051	0.97065	0.24778	4.0358	I.0302	4.1578	5
56	.24079	.97058	.24809	.0307	.0303	.1529	4
57	.24107	.97051	.24840	.0257	.0304	.1481	3
58	.24136	.97044	.24871	.0207	.0305	.1432	2
59	.24164	.97037	.24902	.0157	.0305	.1384	1
60	0.24192	0.97029	0.24933	4.0108	I.0306	4.1336	0
M	Cosine	Sine	Cotan.	Tan.	Cosec.	Secant	M

76°

M	Sine	Cosine	Tan.	Cotan.	Secant	Cosec.	M
0	0.24192	0.97029	0.24933	4.0108	I.0306	4.1336	60
1	.24220	.97022	.24964	.0058	.0307	.1287	59
2	.24249	.97015	.24995	.0009	.0308	.1239	58
3	.24277	.97008	.25025	3.9959	.0308	.1191	57
4	.24305	.97001	.25056	.9910	.0309	.1144	56
5	0.24333	0.96994	0.25087	3.9861	I.0310	4.1096	55
6	.24361	.96987	.25118	.9812	.0311	.1048	54
7	.24390	.96980	.25149	.9763	.0311	.1001	53
8	.24418	.96973	.25180	.9714	.0312	.0953	52
9	.24446	.96966	.25211	.9665	.0313	.0906	51
10	0.24474	0.96959	0.25242	3.9616	I.0314	4.0859	50
11	.24502	.96952	.25273	.9568	.0314	.0812	49
12	.24531	.96944	.25304	.9520	.0315	.0765	48
13	.24559	.96937	.25335	.9471	.0316	.0718	47
14	.24587	.96930	.25366	.9423	.0317	.0672	46
15	0.24615	0.96923	0.25397	3.9375	I.0317	4.0625	45
16	.24643	.96916	.25428	.9327	.0318	.0579	44
17	.24672	.96909	.25459	.9279	.0319	.0532	43
18	.24700	.96901	.25490	.9231	.0320	.0486	42
19	.24728	.96894	.25521	.9184	.0320	.0440	41
20	0.24756	0.96887	0.25552	3.9136	I.0321	4.0394	40
21	.24784	.96880	.25583	.9089	.0322	.0348	39
22	.24813	.96873	.25614	.9042	.0323	.0302	38
23	.24841	.96865	.25645	.8994	.0323	.0256	37
24	.24869	.96858	.25676	.8947	.0324	.0211	36
25	0.24897	0.96851	0.25707	3.8900	I.0325	4.0165	35
26	.24925	.96844	.25738	.8853	.0326	.0120	34
27	.24953	.96836	.25769	.8807	.0327	.0074	33
28	.24982	.96829	.25800	.8760	.0327	.0029	32
29	.25010	.96822	.25831	.8713	.0328	3.9984	31
30	0.25038	0.96815	0.25862	3.8667	I.0329	3.9939	30
31	.25066	.96807	.25893	.8621	.0330	.9894	29
32	.25094	.96800	.25924	.8574	.0330	.9850	28
33	.25122	.96793	.25955	.8528	.0331	.9805	27
34	.25151	.96785	.25986	.8482	.0332	.9760	26
35	0.25179	0.96778	0.26017	3.8436	I.0333	3.9716	25
36	.25207	.96771	.26048	.8390	.0334	.9672	24
37	.25235	.96763	.26079	.8345	.0334	.9627	23
38	.25263	.96756	.26110	.8299	.0335	.9583	22
39	.25291	.96749	.26141	.8254	.0336	.9539	21
40	0.25319	0.96741	0.26172	3.8208	I.0337	3.9495	20
41	.25348	.96734	.26203	.8163	.0338	.9451	19
42	.25376	.96727	.26234	.8118	.0338	.9408	18
43	.25404	.96719	.26266	.8073	.0339	.9364	17
44	.25432	.96712	.26297	.8027	.0340	.9320	16
45	0.25460	0.96704	0.26328	3.7983	I.0341	3.9277	15
46	.25488	.96697	.26359	.7938	.0341	.9234	14
47	.25516	.96690	.26390	.7893	.0342	.9190	13
48	.25544	.96682	.26421	.7848	.0343	.9147	12
49	.25573	.96675	.26452	.7804	.0344	.9104	11
50	0.25601	0.96667	0.26483	3.7759	I.0345	3.9061	10
51	.25629	.96660	.26514	.7715	.0345	.9018	9
52	.25657	.96652	.26546	.7671	.0346	.8976	8
53	.25685	.96645	.26577	.7627	.0347	.8933	7
54	.25713	.96638	.26608	.7583	.0348	.8890	6
55	0.25741	0.96630	0.26639	3.7539	I.0349	3.8848	5
56	.25769	.96623	.26670	.7495	.0349	.8805	4
57	.25798	.96615	.26701	.7451	.0350	.8763	3
58	.25826	.96608	.26732	.7407	.0351	.8721	2
59	.25854	.96600	.26764	.7364	.0352	.8679	1
60	0.25882	0.96592	0.26795	3.7320	I.0353	3.8637	0
M	Cosine	Sine	Cotan.	Tan.	Cosec.	Secant	M

# 15° Natural Trigonometric Functions

M	Sine	Cosine	Tan.	Cotan.	Secant	Cosec.	M
0	0.25882	0.96592	0.26795	3.7320	1.0353	3.8637	60
1	.25910	.96585	.26826	.7277	.0353	.8595	59
2	.25938	.96577	.26857	.7234	.0354	.8553	58
3	.25966	.96570	.26888	.7191	.0355	.8512	57
4	.25994	.96562	.26920	.7147	.0356	.8470	56
5	0.26022	0.96555	0.26951	3.7104	1.0357	3.8428	55
6	.26050	.96547	.26982	.7062	.0358	.8387	54
7	.26078	.96540	.27013	.7019	.0358	.8346	53
8	.26107	.96532	.27044	.6976	.0359	.8304	52
9	.26135	.96524	.27076	.6933	.0360	.8263	51
10	0.26163	0.96517	0.27107	3.6891	1.0361	3.8222	50
11	.26191	.96509	.27138	.6848	.0362	.8181	49
12	.26219	.96502	.27169	.6806	.0362	.8140	48
13	.26247	.96494	.27201	.6764	.0363	.8100	47
14	.26275	.96486	.27232	.6722	.0364	.8059	46
15	0.26303	0.96479	0.27263	3.6679	1.0365	3.8018	45
16	.26331	.96471	.27294	.6637	.0366	.7978	44
17	.26359	.96463	.27326	.6596	.0367	.7937	43
18	.26387	.96456	.27357	.6554	.0367	.7897	42
19	.26415	.96448	.27388	.6512	.0368	.7857	41
20	0.26443	0.96440	0.27419	3.6470	1.0369	3.7816	40
21	.26471	.96433	.27451	.6429	.0370	.7776	39
22	.26499	.96425	.27482	.6387	.0371	.7736	38
23	.26527	.96417	.27513	.6346	.0371	.7697	37
24	.26556	.96409	.27544	.6305	.0372	.7657	36
25	0.26584	0.96402	0.27576	3.6263	1.0373	3.7617	35
26	.26612	.96394	.27607	.6222	.0374	.7577	34
27	.26640	.96386	.27638	.6181	.0375	.7538	33
28	.26668	.96378	.27670	.6140	.0376	.7498	32
29	.26696	.96371	.27701	.6100	.0376	.7459	31
30	0.26724	0.96363	0.27732	3.6059	1.0377	3.7420	30
31	.26752	.96355	.27764	.6018	.0378	.7380	29
32	.26780	.96347	.27795	.5977	.0379	.7341	28
33	.26808	.96340	.27826	.5937	.0380	.7302	27
34	.26836	.96332	.27858	.5896	.0381	.7263	26
35	0.26864	0.96324	0.27889	3.5856	1.0382	3.7224	25
36	.26892	.96316	.27920	.5816	.0382	.7186	24
37	.26920	.96308	.27952	.5776	.0383	.7147	23
38	.26948	.96301	.27983	.5736	.0384	.7108	22
39	.26976	.96293	.28014	.5696	.0385	.7070	21
40	0.27004	0.96285	0.28046	3.5656	1.0386	3.7031	20
41	.27032	.96277	.28077	.5616	.0387	.6993	19
42	.27060	.96269	.28109	.5576	.0387	.6955	18
43	.27088	.96261	.28140	.5536	.0388	.6917	17
44	.27116	.96253	.28171	.5497	.0389	.6878	16
45	0.27144	0.96245	0.28203	3.5457	1.0390	3.6840	15
46	.27172	.96238	.28234	.5418	.0391	.6802	14
47	.27200	.96230	.28266	.5378	.0392	.6765	13
48	.27228	.96222	.28297	.5339	.0393	.6727	12
49	.27256	.96214	.28328	.5300	.0393	.6689	11
50	0.27284	0.96206	0.28360	3.5261	1.0394	3.6651	10
51	.27312	.96198	.28391	.5222	.0395	.6614	9
52	.27340	.96190	.28423	.5183	.0396	.6576	8
53	.27368	.96182	.28454	.5144	.0397	.6539	7
54	.27396	.96174	.28486	.5105	.0398	.6502	6
55	0.27424	0.96166	0.28517	3.5066	1.0399	3.6464	5
56	.27452	.96158	.28549	.5028	.0399	.6427	4
57	.27480	.96150	.28580	.4989	.0400	.6390	3
58	.27508	.96142	.28611	.4951	.0401	.6353	2
59	.27536	.96134	.28643	.4912	.0402	.6316	1
60	0.27564	0.96126	0.28674	3.4874	1.0403	3.6279	0
M	Cosine	Sine	Cotan.	Tan.	Cosec.	Secant	M

# 16° Natural Trigonometric Functions

M	Sine	Cosine	Tan.	Cotan.	Secant	Cosec.	M
0	0.27564	0.96126	0.28674	3.4874	I.0403	3.6279	60
1	.27592	.96118	.28706	.4836	.0404	.6243	59
2	.27620	.96110	.28737	.4798	.0405	.6206	58
3	.27648	.96102	.28769	.4760	.0406	.6169	57
4	.27675	.96094	.28800	.4722	.0406	.6133	56
5	0.27703	0.96086	0.28832	3.4684	I.0407	3.6096	55
6	.27731	.96078	.28863	.4646	.0408	.6060	54
7	.27759	.96070	.28895	.4608	.0409	.6024	53
8	.27787	.96062	.28926	.4570	.0410	.5987	52
9	.27815	.96054	.28958	.4533	.0411	.5951	51
10	0.27843	0.96045	0.28990	3.4495	I.0412	3.5915	50
11	.27871	.96037	.29021	.4458	.0413	.5879	49
12	.27899	.96029	.29053	.4420	.0413	.5843	48
13	.27927	.96021	.29084	.4383	.0414	.5807	47
14	.27955	.96013	.29116	.4346	.0415	.5772	46
15	0.27983	0.96005	0.29147	3.4308	I.0416	3.5736	45
16	.28011	.95997	.29179	.4271	.0417	.5700	44
17	.28039	.95989	.29210	.4234	.0418	.5665	43
18	.28067	.95980	.29242	.4197	.0419	.5629	42
19	.28094	.95972	.29274	.4160	.0420	.5594	41
20	0.28122	0.95964	0.29305	3.4124	I.0420	3.5559	40
21	.28150	.95956	.29337	.4087	.0421	.5523	39
22	.28178	.95948	.29368	.4050	.0422	.5488	38
23	.28206	.95940	.29400	.4014	.0423	.5453	37
24	.28234	.95931	.29432	.3977	.0424	.5418	36
25	0.28262	0.95923	0.29463	3.3941	I.0425	3.5383	35
26	.28290	.95915	.29495	.3904	.0426	.5348	34
27	.28318	.95907	.29526	.3868	.0427	.5313	33
28	.28346	.95898	.29558	.3832	.0428	.5279	32
29	.28374	.95890	.29590	.3795	.0428	.5244	31
30	0.28401	0.95882	0.29621	3.3759	I.0429	3.5209	30
31	.28429	.95874	.29653	.3723	.0430	.5175	29
32	.28457	.95865	.29685	.3687	.0431	.5140	28
33	.28485	.95857	.29716	.3651	.0432	.5106	27
34	.28513	.95849	.29748	.3616	.0433	.5072	26
35	0.28541	0.95840	0.29780	3.3580	I.0434	3.5037	25
36	.28569	.95832	.29811	.3544	.0435	.5003	24
37	.28597	.95824	.29843	.3509	.0436	.4969	23
38	.28624	.95816	.29875	.3473	.0437	.4935	22
39	.28652	.95807	.29906	.3438	.0438	.4901	21
40	0.28680	0.95799	0.29938	3.3402	I.0438	3.4867	20
41	.28708	.95791	.29970	.3367	.0439	.4833	19
42	.28736	.95782	.30001	.3332	.0440	.4799	18
43	.28764	.95774	.30033	.3296	.0441	.4766	17
44	.28792	.95765	.30065	.3261	.0442	.4732	16
45	0.28820	0.95757	0.30096	3.3226	I.0443	3.4698	15
46	.28847	.95749	.30128	.3191	.0444	.4665	14
47	.28875	.95740	.30160	.3156	.0445	.4632	13
48	.28903	.95732	.30192	.3121	.0446	.4598	12
49	.28931	.95723	.30223	.3087	.0447	.4565	11
50	0.28959	0.95715	0.30255	3.3052	I.0448	3.4532	10
51	.28987	.95707	.30287	.3017	.0448	.4498	9
52	.29014	.95698	.30319	.2983	.0449	.4465	8
53	.29042	.95690	.30350	.2948	.0450	.4432	7
54	.29070	.95681	.30382	.2914	.0451	.4399	6
55	0.29098	0.95673	0.30414	3.2879	I.0452	3.4366	5
56	.29126	.95664	.30446	.2845	.0453	.4334	4
57	.29154	.95656	.30478	.2811	.0454	.4301	3
58	.29181	.95647	.30509	.2777	.0455	.4268	2
59	.29209	.95639	.30541	.2742	.0456	.4236	1
60	0.29237	0.95630	0.30573	3.2708	I.0457	3.4203	0
M	Cosine	Sine	Cotan.	Tan.	Cosec.	Secant	M

# 17° Natural Trigonometric Functions

M	Sine	Cosine	Tan.	Cotan.	Secant	Cosec.	M
0	0.29237	0.95630	0.30573	3.2708	1.0457	3.4203	60
1	.29265	.95622	.30605	.2674	.0458	.4170	59
2	.29293	.95613	.30637	.2640	.0459	.4138	58
3	.29321	.95605	.30668	.2607	.0460	.4106	57
4	.29348	.95596	.30700	.2573	.0461	.4073	56
5	0.29376	0.95588	0.30732	3.2539	1.0461	3.4041	55
6	.29404	.95579	.30764	.2505	.0462	.4009	54
7	.29432	.95571	.30796	.2472	.0463	.3977	53
8	.29460	.95562	.30828	.2438	.0464	.3945	52
9	.29487	.95554	.30859	.2405	.0465	.3913	51
10	0.29515	0.95545	0.30891	3.2371	1.0466	3.3881	50
11	.29543	.95536	.30923	.2338	.0467	.3849	49
12	.29571	.95528	.30955	.2305	.0468	.3817	48
13	.29598	.95519	.30987	.2271	.0469	.3785	47
14	.29626	.95511	.31019	.2238	.0470	.3754	46
15	0.29654	0.95502	0.31051	3.2205	1.0471	3.3722	45
16	.29682	.95493	.31083	.2172	.0472	.3690	44
17	.29710	.95485	.31115	.2139	.0473	.3659	43
18	.29737	.95476	.31146	.2106	.0474	.3627	42
19	.29765	.95467	.31178	.2073	.0475	.3596	41
20	0.29793	0.95459	0.31210	3.2041	1.0476	3.3565	40
21	.29821	.95450	.31242	.2008	.0477	.3534	39
22	.29848	.95441	.31274	.1975	.0478	.3502	38
23	.29876	.95433	.31306	.1942	.0478	.3471	37
24	.29904	.95424	.31338	.1910	.0479	.3440	36
25	0.29932	0.95415	0.31370	3.1877	1.0480	3.3409	35
26	.29959	.95407	.31402	.1845	.0481	.3378	34
27	.29987	.95398	.31434	.1813	.0482	.3347	33
28	.30015	.95389	.31466	.1780	.0483	.3316	32
29	.30043	.95380	.31498	.1748	.0484	.3286	31
30	0.30070	0.95372	0.31530	3.1716	1.0485	3.3255	30
31	.30098	.95363	.31562	.1684	.0486	.3224	29
32	.30126	.95354	.31594	.1652	.0487	.3194	28
33	.30154	.95345	.31626	.1620	.0488	.3163	27
34	.30181	.95337	.31658	.1588	.0489	.3133	26
35	0.30209	0.95328	0.31690	3.1556	1.0490	3.3102	25
36	.30237	.95319	.31722	.1524	.0491	.3072	24
37	.30265	.95310	.31754	.1492	.0492	.3042	23
38	.30292	.95301	.31786	.1460	.0493	.3011	22
39	.30320	.95293	.31818	.1429	.0494	.2981	21
40	0.30348	0.95284	0.31850	3.1397	1.0495	3.2951	20
41	.30375	.95275	.31882	.1366	.0496	.2921	19
42	.30403	.95266	.31914	.1334	.0497	.2891	18
43	.30431	.95257	.31946	.1303	.0498	.2861	17
44	.30459	.95248	.31978	.1271	.0499	.2831	16
45	0.30486	0.95239	0.32010	3.1240	1.0500	3.2801	15
46	.30514	.95231	.32042	.1209	.0501	.2772	14
47	.30542	.95222	.32074	.1177	.0502	.2742	13
48	.30569	.95213	.32106	.1146	.0503	.2712	12
49	.30597	.95204	.32138	.1115	.0504	.2683	11
50	0.30625	0.95195	0.32171	3.1084	1.0505	3.2653	10
51	.30653	.95186	.32203	.1053	.0506	.2624	9
52	.30680	.95177	.32235	.1022	.0507	.2594	8
53	.30708	.95168	.32267	.0991	.0508	.2565	7
54	.30736	.95159	.32299	.0960	.0509	.2535	6
55	0.30763	0.95150	0.32331	3.0930	1.0510	3.2506	5
56	.30791	.95141	.32363	.0899	.0511	.2477	4
57	.30819	.95132	.32395	.0868	.0512	.2448	3
58	.30846	.95124	.32428	.0838	.0513	.2419	2
59	.30874	.95115	.32460	.0807	.0514	.2390	1
60	0.30902	0.95106	0.32492	3.0777	1.0515	3.2361	0
M	Cosine	Sine	Cotan.	Tan.	Cosec.	Secant	M

18° Natural Trigonometric Functions

M	Sine	Cosine	Tan.	Cotan.	Secant	Cosec.	M
0	0.30902	0.95106	0.32492	3.0777	I.0515	3.2361	60
1	.30929	.95097	.32524	.0746	.0516	.2332	59
2	.30957	.95088	.32556	.0716	.0517	.2303	58
3	.30985	.95079	.32588	.0686	.0518	.2274	57
4	.31012	.95070	.32621	.0655	.0519	.2245	56
5	0.31040	0.95061	0.32653	3.0625	I.0520	3.2216	55
6	.31063	.95051	.32685	.0595	.0521	.2188	54
7	.31095	.95042	.32717	.0565	.0522	.2159	53
8	.31123	.95033	.32749	.0535	.0523	.2131	52
9	.31150	.95024	.32782	.0505	.0524	.2102	51
10	0.31178	0.95015	0.32814	3.0475	I.0525	3.2074	50
11	.31206	.95006	.32846	.0445	.0526	.2045	49
12	.31233	.94997	.32878	.0415	.0527	.2017	48
13	.31261	.94988	.32910	.0385	.0528	.1989	47
14	.31289	.94979	.32943	.0356	.0529	.1960	46
15	0.31316	0.94970	0.32975	3.0326	I.0530	3.1932	45
16	.31344	.94961	.33007	.0296	.0531	.1904	44
17	.31372	.94952	.33039	.0267	.0532	.1876	43
18	.31399	.94942	.33072	.0237	.0533	.1848	42
19	.31427	.94933	.33104	.0208	.0534	.1820	41
20	0.31454	0.94924	0.33136	3.0178	I.0535	3.1792	40
21	.31482	.94915	.33169	.0149	.0536	.1764	39
22	.31510	.94906	.33201	.0120	.0537	.1736	38
23	.31537	.94897	.33233	.0090	.0538	.1708	37
24	.31565	.94888	.33265	.0061	.0539	.1680	36
25	0.31592	0.94878	0.33298	3.0032	I.0540	3.1653	35
26	.31620	.94869	.33330	.0003	.0541	.1625	34
27	.31648	.94860	.33362	2.9974	.0542	.1598	33
28	.31675	.94851	.33395	.9945	.0543	.1570	32
29	.31703	.94841	.33427	.9916	.0544	.1543	31
30	0.31730	0.94832	0.33459	2.9887	I.0545	3.1515	30
31	.31758	.94823	.33492	.9858	.0546	.1488	29
32	.31786	.94814	.33524	.9829	.0547	.1461	28
33	.31813	.94805	.33557	.9800	.0548	.1433	27
34	.31841	.94795	.33589	.9772	.0549	.1406	26
35	0.31868	0.94786	0.33621	2.9743	I.0550	3.1379	25
36	.31896	.94777	.33654	.9714	.0551	.1352	24
37	.31923	.94767	.33686	.9686	.0552	.1325	23
38	.31951	.94758	.33718	.9657	.0553	.1298	22
39	.31978	.94749	.33751	.9629	.0554	.1271	21
40	0.32006	0.94740	0.33783	2.9600	I.0555	3.1244	20
41	.32034	.94730	.33816	.9572	.0556	.1217	19
42	.32061	.94721	.33848	.9544	.0557	.1190	18
43	.32089	.94712	.33880	.9515	.0558	.1163	17
44	.32116	.94702	.33913	.9487	.0559	.1137	16
45	0.32144	0.94693	0.33945	2.9459	I.0560	3.1110	15
46	.32171	.94684	.33978	.9431	.0561	.1083	14
47	.32199	.94674	.34010	.9403	.0562	.1057	13
48	.32226	.94665	.34043	.9375	.0563	.1030	12
49	.32254	.94655	.34075	.9347	.0565	.1004	11
50	0.32282	0.94646	0.34108	2.9319	I.0566	3.0977	10
51	.32309	.94637	.34140	.9291	.0567	.0951	9
52	.32337	.94627	.34173	.9263	.0568	.0925	8
53	.32364	.94618	.34205	.9235	.0569	.0898	7
54	.32392	.94608	.34238	.9208	.0570	.0872	6
55	0.32419	0.94599	0.34270	2.9180	I.0571	3.0846	5
56	.32447	.94590	.34303	.9152	.0572	.0820	4
57	.32474	.94580	.34335	.9125	.0573	.0793	3
58	.32502	.94571	.34368	.9097	.0574	.0767	2
59	.32529	.94561	.34400	.9069	.0575	.0741	1
60	0.32557	0.94552	0.34433	2.9042	I.0576	3.0715	0
M	Cosine	Sine	Cotan.	Tan.	Cosec.	Secant	M

19° Natural Trigonometric Functions

M	Sine	Cosine	Tan.	Cotan.	Secant	Cosec.	M
0	0.32557	0.94552	0.34433	2.9042	1.0576	3.0715	60
1	.32534	.94542	.34465	.9015	.0577	.0690	59
2	.32612	.94533	.34498	.8987	.0578	.0664	58
3	.32639	.94523	.34530	.8960	.0579	.0638	57
4	.32667	.94514	.34563	.8933	.0580	.0612	56
5	0.32694	0.94504	0.34595	2.8905	1.0581	3.0586	55
6	.32722	.94495	.34628	.8878	.0582	.0561	54
7	.32749	.94485	.34661	.8851	.0584	.0535	53
8	.32777	.94476	.34693	.8824	.0585	.0509	52
9	.32804	.94466	.34726	.8797	.0586	.0484	51
10	0.32832	0.94457	0.34758	2.8770	1.0587	3.0458	50
11	.32859	.94447	.34791	.8743	.0588	.0433	49
12	.32887	.94438	.34824	.8716	.0589	.0407	48
13	.32914	.94428	.34856	.8689	.0590	.0382	47
14	.32942	.94418	.34889	.8662	.0591	.0357	46
15	0.32969	0.94409	0.34921	2.8636	1.0592	3.0331	45
16	.32996	.94399	.34954	.8609	.0593	.0306	44
17	.33024	.94390	.34987	.8582	.0594	.0281	43
18	.33051	.94380	.35019	.8555	.0595	.0256	42
19	.33079	.94370	.35052	.8529	.0596	.0231	41
20	0.33106	0.94361	0.35085	2.8502	1.0598	3.0206	40
21	.33134	.94351	.35117	.8476	.0599	.0181	39
22	.33161	.94341	.35150	.8449	.0600	.0156	38
23	.33189	.94332	.35183	.8423	.0601	.0131	37
24	.33216	.94322	.35215	.8396	.0602	.0106	36
25	0.33243	0.94313	0.35248	2.8370	1.0603	3.0081	35
26	.33271	.94303	.35281	.8344	.0604	.0056	34
27	.33298	.94293	.35314	.8318	.0605	.0031	33
28	.33326	.94283	.35346	.8291	.0606	.0007	32
29	.33353	.94274	.35379	.8265	.0607	2.9982	31
30	0.33381	0.94264	0.35412	2.8239	1.0608	2.9957	30
31	.33408	.94254	.35445	.8213	.0609	.9933	29
32	.33435	.94245	.35477	.8187	.0611	.9908	28
33	.33463	.94235	.35510	.8161	.0612	.9884	27
34	.33490	.94225	.35543	.8135	.0613	.9859	26
35	0.33518	0.94215	0.35576	2.8109	1.0614	2.9835	25
36	.33545	.94206	.35608	.8083	.0615	.9810	24
37	.33572	.94196	.35641	.8057	.0616	.9786	23
38	.33600	.94186	.35674	.8032	.0617	.9762	22
39	.33627	.94176	.35707	.8006	.0618	.9738	21
40	0.33655	0.94167	0.35739	2.7980	1.0619	2.9713	20
41	.33682	.94157	.35772	.7954	.0620	.9689	19
42	.33709	.94147	.35805	.7929	.0622	.9665	18
43	.33737	.94137	.35838	.7903	.0623	.9641	17
44	.33764	.94127	.35871	.7878	.0624	.9617	16
45	0.33792	0.94118	0.35904	2.7852	1.0625	2.9593	15
46	.33819	.94108	.35936	.7827	.0626	.9569	14
47	.33846	.94098	.35969	.7801	.0627	.9545	13
48	.33874	.94088	.36002	.7776	.0628	.9521	12
49	.33901	.94078	.36035	.7751	.0629	.9497	11
50	0.33928	0.94068	0.36068	2.7725	1.0630	2.9474	10
51	.33956	.94058	.36101	.7700	.0632	.9450	9
52	.33983	.94049	.36134	.7675	.0633	.9426	8
53	.34011	.94039	.36167	.7650	.0634	.9402	7
54	.34038	.94029	.36199	.7625	.0635	.9379	6
55	0.34065	0.94019	0.36232	2.7600	1.0636	2.9355	5
56	.34093	.94009	.36265	.7575	.0637	.9332	4
57	.34120	.93999	.36298	.7550	.0638	.9308	3
58	.34147	.93989	.36331	.7525	.0639	.9285	2
59	.34175	.93979	.36364	.7500	.0641	.9261	1
60	0.34202	0.93969	0.36397	2.7475	1.0642	2.9238	0
M	Cosine	Sine	Cotan.	Tan.	Cosec.	Secant	M

# 20° Natural Trigonometric Functions

M	Sine	Cosine	Tan.	Cotan.	Secant	Cosec.	M
0	0.34202	0.93969	0.36397	2.7475	I.0642	2.9238	60
1	.34229	.93959	.36430	.7450	.0643	.9215	59
2	.34257	.93949	.36463	.7425	.0644	.9191	58
3	.34284	.93939	.36496	.7400	.0645	.9168	57
4	.34311	.93929	.36529	.7376	.0646	.9145	56
5	0.34339	0.93919	0.36562	2.7351	I.0647	2.9122	55
6	.34366	.93909	.36595	.7326	.0648	.9098	54
7	.34393	.93899	.36628	.7302	.0650	.9075	53
8	.34421	.93889	.36661	.7277	.0651	.9052	52
9	.34448	.93879	.36694	.7252	.0652	.9029	51
10	0.34475	0.93869	0.36727	2.7228	I.0653	2.9006	50
11	.34502	.93859	.36760	.7204	.0654	.8983	49
12	.34530	.93849	.36793	.7179	.0655	.8960	48
13	.34557	.93839	.36826	.7155	.0656	.8937	47
14	.34584	.93829	.36859	.7130	.0658	.8915	46
15	0.34612	0.93819	0.36892	2.7106	I.0659	2.8892	45
16	.34639	.93809	.36925	.7082	.0660	.8869	44
17	.34666	.93799	.36958	.7058	.0661	.8846	43
18	.34693	.93789	.36991	.7033	.0662	.8824	42
19	.34721	.93779	.37024	.7009	.0663	.8801	41
20	0.34748	0.93769	0.37057	2.6985	I.0664	2.8778	40
21	.34775	.93758	.37090	.6961	.0666	.8756	39
22	.34803	.93748	.37123	.6937	.0667	.8733	38
23	.34830	.93738	.37156	.6913	.0668	.8711	37
24	.34857	.93728	.37190	.6889	.0669	.8688	36
25	0.34884	0.93718	0.37223	2.6865	I.0670	2.8666	35
26	.34912	.93708	.37256	.6841	.0671	.8644	34
27	.34939	.93698	.37289	.6817	.0673	.8621	33
28	.34966	.93687	.37322	.6794	.0674	.8599	32
29	.34993	.93677	.37355	.6770	.0675	.8577	31
30	0.35021	0.93667	0.37388	2.6746	I.0676	2.8554	30
31	.35048	.93657	.37422	.6722	.0677	.8532	29
32	.35075	.93647	.37455	.6699	.0678	.8510	28
33	.35102	.93637	.37488	.6675	.0679	.8488	27
34	.35130	.93626	.37521	.6652	.0681	.8466	26
35	0.35157	0.93616	0.37554	2.6628	I.0682	2.8444	25
36	.35184	.93606	.37587	.6604	.0683	.8422	24
37	.35211	.93596	.37621	.6581	.0684	.8400	23
38	.35239	.93585	.37654	.6558	.0685	.8378	22
39	.35266	.93575	.37687	.6534	.0686	.8356	21
40	0.35293	0.93565	0.37720	2.6511	I.0688	2.8334	20
41	.35320	.93555	.37754	.6487	.0689	.8312	19
42	.35347	.93544	.37787	.6464	.0690	.8290	18
43	.35375	.93534	.37820	.6441	.0691	.8269	17
44	.35402	.93524	.37853	.6418	.0692	.8247	16
45	0.35429	0.93513	0.37887	2.6394	I.0694	2.8225	15
46	.35456	.93503	.37920	.6371	.0695	.8204	14
47	.35483	.93493	.37953	.6348	.0696	.8182	13
48	.35511	.93482	.37986	.6325	.0697	.8160	12
49	.35538	.93472	.38020	.6302	.0698	.8139	11
50	0.35565	0.93462	0.38053	2.6279	I.0699	2.8117	10
51	.35592	.93451	.38086	.6256	.0701	.8096	9
52	.35619	.93441	.38120	.6233	.0702	.8074	8
53	.35647	.93431	.38153	.6210	.0703	.8053	7
54	.35674	.93420	.38186	.6187	.0704	.8032	6
55	0.35701	0.93410	0.38220	2.6164	I.0705	2.8010	5
56	.35728	.93400	.38253	.6142	.0707	.7989	4
57	.35755	.93389	.38286	.6119	.0708	.7968	3
58	.35782	.93379	.38320	.6096	.0709	.7947	2
59	.35810	.93368	.38353	.6073	.0710	.7925	1
60	0.35837	0.93358	0.38386	2.6051	I.0711	2.7904	0
M	Cosine	Sine	Cotan.	Tan.	Cosec.	Secant	M



# 21° Natural Trigonometric Functions

M	Sine	Cosine	Tan.	Cotan.	Secant	Cosec.	M
0	0.35837	0.93358	0.38386	2.6051	1.0711	2.7904	60
1	.35864	.93343	.38420	.6028	.0713	.7883	59
2	.35891	.93327	.38453	.6006	.0714	.7862	58
3	.35918	.93311	.38486	.5983	.0715	.7841	57
4	.35945	.93295	.38520	.5960	.0716	.7820	56
5	0.35972	0.93279	0.38553	2.5938	1.0717	2.7799	55
6	.36000	.93263	.38587	.5916	.0719	.7778	54
7	.36027	.93247	.38620	.5893	.0720	.7757	53
8	.36054	.93231	.38654	.5871	.0721	.7736	52
9	.36081	.93215	.38687	.5848	.0722	.7715	51
10	0.36108	0.93199	0.38720	2.5826	1.0723	2.7694	50
11	.36135	.93183	.38754	.5804	.0725	.7674	49
12	.36162	.93167	.38787	.5781	.0726	.7653	48
13	.36189	.93151	.38821	.5759	.0727	.7632	47
14	.36217	.93135	.38854	.5737	.0728	.7611	46
15	0.36244	0.93119	0.38888	2.5715	1.0729	2.7591	45
16	.36271	.93103	.38921	.5693	.0731	.7570	44
17	.36298	.93087	.38955	.5671	.0732	.7550	43
18	.36325	.93071	.38988	.5649	.0733	.7529	42
19	.36352	.93055	.39022	.5627	.0734	.7509	41
20	0.36379	0.93039	0.39055	2.5605	1.0736	2.7488	40
21	.36406	.93023	.39089	.5583	.0737	.7468	39
22	.36433	.93007	.39122	.5561	.0738	.7447	38
23	.36460	.92991	.39156	.5539	.0739	.7427	37
24	.36488	.92975	.39189	.5517	.0740	.7406	36
25	0.36515	0.92959	0.39223	2.5495	1.0742	2.7386	35
26	.36542	.92943	.39257	.5473	.0743	.7366	34
27	.36569	.92927	.39290	.5451	.0744	.7346	33
28	.36596	.92911	.39324	.5430	.0745	.7325	32
29	.36623	.92895	.39357	.5408	.0747	.7305	31
30	0.36650	0.92879	0.39391	2.5386	1.0748	2.7285	30
31	.36677	.92863	.39425	.5365	.0749	.7265	29
32	.36704	.92847	.39458	.5343	.0750	.7245	28
33	.36731	.92831	.39492	.5322	.0751	.7225	27
34	.36758	.92815	.39525	.5300	.0753	.7205	26
35	0.36785	0.92799	0.39559	2.5278	1.0754	2.7185	25
36	.36812	.92783	.39593	.5257	.0755	.7165	24
37	.36839	.92767	.39626	.5236	.0756	.7145	23
38	.36866	.92751	.39660	.5214	.0758	.7125	22
39	.36893	.92735	.39694	.5193	.0759	.7105	21
40	0.36921	0.92719	0.39727	2.5171	1.0760	2.7085	20
41	.36948	.92703	.39761	.5150	.0761	.7065	19
42	.36975	.92687	.39795	.5129	.0763	.7045	18
43	.37002	.92671	.39828	.5108	.0764	.7026	17
44	.37029	.92655	.39862	.5086	.0765	.7006	16
45	0.37056	0.92639	0.39896	2.5065	1.0766	2.6986	15
46	.37083	.92623	.39930	.5044	.0768	.6967	14
47	.37110	.92607	.39963	.5023	.0769	.6947	13
48	.37137	.92591	.39997	.5002	.0770	.6927	12
49	.37164	.92575	.40031	.4981	.0771	.6908	11
50	0.37191	0.92559	0.40065	2.4960	1.0773	2.6888	10
51	.37218	.92543	.40098	.4939	.0774	.6869	9
52	.37245	.92527	.40132	.4918	.0775	.6849	8
53	.37272	.92511	.40166	.4897	.0776	.6830	7
54	.37299	.92495	.40200	.4876	.0778	.6810	6
55	0.37326	0.92479	0.40233	2.4855	1.0779	2.6791	5
56	.37353	.92463	.40267	.4834	.0780	.6772	4
57	.37380	.92447	.40301	.4813	.0781	.6752	3
58	.37407	.92431	.40335	.4792	.0783	.6733	2
59	.37434	.92415	.40369	.4772	.0784	.6714	1
60	0.37461	0.92399	0.40403	2.4751	1.0785	2.6695	0
M	Cosine	Sine	Cotan.	Tan.	Cosec.	Secant	M

# 22° Natural Trigonometric Functions

M	Sine	Cosine	Tan.	Cotan.	Secant	Cosec.	M
0	0.37461	0.92718	0.40403	2.4751	1.0785	2.6695	60
1	.37488	.92707	.40436	.4730	.0787	.6675	59
2	.37514	.92696	.40470	.4709	.0788	.6656	58
3	.37541	.92686	.40504	.4689	.0789	.6637	57
4	.37568	.92675	.40538	.4668	.0790	.6618	56
5	0.37595	0.92664	0.40572	2.4647	1.0792	2.6599	55
6	.37622	.92653	.40606	.4627	.0793	.6580	54
7	.37649	.92642	.40640	.4606	.0794	.6561	53
8	.37676	.92631	.40673	.4586	.0795	.6542	52
9	.37703	.92620	.40707	.4565	.0797	.6523	51
10	0.37730	0.92609	0.40741	2.4545	1.0798	2.6504	50
11	.37757	.92598	.40775	.4525	.0799	.6485	49
12	.37784	.92587	.40809	.4504	.0801	.6466	48
13	.37811	.92576	.40843	.4484	.0802	.6447	47
14	.37838	.92565	.40877	.4463	.0803	.6428	46
15	0.37865	0.92554	0.40911	2.4443	1.0804	2.6410	45
16	.37892	.92543	.40945	.4423	.0806	.6391	44
17	.37919	.92532	.40979	.4403	.0807	.6372	43
18	.37946	.92521	.41013	.4382	.0808	.6353	42
19	.37972	.92510	.41047	.4362	.0810	.6335	41
20	0.37999	0.92499	0.41081	2.4342	1.0811	2.6316	40
21	.38026	.92488	.41115	.4322	.0812	.6297	39
22	.38053	.92477	.41149	.4302	.0813	.6279	38
23	.38080	.92466	.41183	.4282	.0815	.6260	37
24	.38107	.92455	.41217	.4262	.0816	.6242	36
25	0.38134	0.92443	0.41251	2.4242	1.0817	2.6223	35
26	.38151	.92432	.41285	.4222	.0819	.6205	34
27	.38188	.92421	.41319	.4202	.0820	.6186	33
28	.38214	.92410	.41353	.4182	.0821	.6168	32
29	.38241	.92399	.41387	.4162	.0823	.6150	31
30	0.38268	0.92388	0.41421	2.4142	1.0824	2.6131	30
31	.38295	.92377	.41455	.4122	.0825	.6113	29
32	.38322	.92366	.41489	.4102	.0826	.6095	28
33	.38349	.92354	.41524	.4083	.0828	.6076	27
34	.38376	.92343	.41558	.4063	.0829	.6058	26
35	0.38403	0.92332	0.41592	2.4043	1.0830	2.6040	25
36	.38429	.92321	.41626	.4023	.0832	.6022	24
37	.38456	.92310	.41660	.4004	.0833	.6003	23
38	.38483	.92299	.41694	.3984	.0834	.5985	22
39	.38510	.92287	.41728	.3964	.0836	.5967	21
40	0.38537	0.92276	0.41762	2.3945	1.0837	2.5949	20
41	.38564	.92265	.41797	.3925	.0838	.5931	19
42	.38591	.92254	.41831	.3906	.0840	.5913	18
43	.38617	.92242	.41865	.3886	.0841	.5895	17
44	.38644	.92231	.41899	.3867	.0842	.5877	16
45	0.38671	0.92220	0.41933	2.3847	1.0844	2.5859	15
46	.38698	.92209	.41968	.3828	.0845	.5841	14
47	.38725	.92197	.42002	.3808	.0846	.5823	13
48	.38751	.92186	.42036	.3789	.0847	.5805	12
49	.38778	.92175	.42070	.3770	.0849	.5787	11
50	0.38805	0.92164	0.42105	2.3750	1.0850	2.5770	10
51	.38832	.92152	.42139	.3731	.0851	.5752	9
52	.38859	.92141	.42173	.3712	.0853	.5734	8
53	.38886	.92130	.42207	.3692	.0854	.5716	7
54	.38912	.92118	.42242	.3673	.0855	.5699	6
55	0.38939	0.92107	0.42276	2.3654	1.0857	2.5681	5
56	.38966	.92096	.42310	.3635	.0858	.5663	4
57	.38993	.92084	.42344	.3616	.0859	.5646	3
58	.39019	.92073	.42379	.3597	.0861	.5628	2
59	.39046	.92062	.42413	.3577	.0862	.5610	1
60	0.39073	0.92050	0.42447	2.3558	1.0864	2.5593	0
M	Cosine	Sine	Cotan.	Tan.	Cosec.	Secant	M

## 23° Natural Trigonometric Functions

M	Sine	Cosine	Tan.	Cotan.	Secant	Cosec.	M
0	0.39073	0.92050	0.42447	2.3558	1.0864	2.5593	60
1	.39100	.92039	.42482	.3539	.0865	.5575	59
2	.39126	.92028	.42516	.3520	.0866	.5558	58
3	.39153	.92016	.42550	.3501	.0868	.5540	57
4	.39180	.92005	.42585	.3482	.0869	.5523	56
5	0.39207	0.91993	0.42619	2.3463	1.0870	2.5506	55
6	.39234	.91982	.42654	.3445	.0872	.5488	54
7	.39260	.91971	.42688	.3426	.0873	.5471	53
8	.39287	.91959	.42722	.3407	.0874	.5453	52
9	.39314	.91948	.42757	.3388	.0876	.5436	51
10	0.39341	0.91936	0.42791	2.3369	1.0877	2.5419	50
11	.39367	.91925	.42826	.3350	.0878	.5402	49
12	.39394	.91913	.42860	.3332	.0880	.5384	48
13	.39421	.91902	.42894	.3313	.0881	.5367	47
14	.39448	.91891	.42929	.3294	.0882	.5350	46
15	0.39474	0.91879	0.42963	2.3276	1.0884	2.5333	45
16	.39501	.91868	.42998	.3257	.0885	.5316	44
17	.39528	.91856	.43032	.3238	.0886	.5299	43
18	.39554	.91845	.43067	.3220	.0888	.5281	42
19	.39581	.91833	.43101	.3201	.0889	.5264	41
20	0.39608	0.91822	0.43136	2.3183	1.0891	2.5247	40
21	.39635	.91810	.43170	.3164	.0892	.5230	39
22	.39661	.91798	.43205	.3145	.0893	.5213	38
23	.39688	.91787	.43239	.3127	.0895	.5196	37
24	.39715	.91775	.43274	.3109	.0896	.5179	36
25	0.39741	0.91764	0.43308	2.3090	1.0897	2.5163	35
26	.39768	.91752	.43343	.3072	.0899	.5146	34
27	.39795	.91741	.43377	.3053	.0900	.5129	33
28	.39821	.91729	.43412	.3035	.0902	.5112	32
29	.39848	.91718	.43447	.3017	.0903	.5095	31
30	0.39875	0.91706	0.43481	2.2998	1.0904	2.5078	30
31	.39901	.91694	.43516	.2980	.0906	.5062	29
32	.39928	.91683	.43550	.2962	.0907	.5045	28
33	.39955	.91671	.43585	.2944	.0908	.5028	27
34	.39981	.91659	.43620	.2925	.0910	.5011	26
35	0.40008	0.91648	0.43654	2.2907	1.0911	2.4995	25
36	.40035	.91636	.43689	.2889	.0913	.4978	24
37	.40061	.91625	.43723	.2871	.0914	.4961	23
38	.40088	.91613	.43758	.2853	.0915	.4945	22
39	.40115	.91601	.43793	.2835	.0917	.4928	21
40	0.40141	0.91590	0.43827	2.2817	1.0918	2.4912	20
41	.40168	.91578	.43862	.2799	.0920	.4895	19
42	.40195	.91566	.43897	.2781	.0921	.4879	18
43	.40221	.91554	.43932	.2763	.0922	.4862	17
44	.40248	.91543	.43966	.2745	.0924	.4846	16
45	0.40275	0.91531	0.44001	2.2727	1.0925	2.4829	15
46	.40301	.91519	.44036	.2709	.0927	.4813	14
47	.40328	.91508	.44070	.2691	.0928	.4797	13
48	.40354	.91496	.44105	.2673	.0929	.4780	12
49	.40381	.91484	.44140	.2655	.0931	.4764	11
50	0.40408	0.91472	0.44175	2.2637	1.0932	2.4748	10
51	.40434	.91461	.44209	.2619	.0934	.4731	9
52	.40461	.91449	.44244	.2602	.0935	.4715	8
53	.40487	.91437	.44279	.2584	.0936	.4699	7
54	.40514	.91425	.44314	.2566	.0938	.4683	6
55	0.40541	0.91414	0.44349	2.2548	1.0939	2.4666	5
56	.40567	.91402	.44383	.2531	.0941	.4650	4
57	.40594	.91390	.44418	.2513	.0942	.4634	3
58	.40620	.91378	.44453	.2495	.0943	.4618	2
59	.40647	.91366	.44488	.2478	.0945	.4602	1
60	0.40674	0.91354	0.44523	2.2460	1.0946	2.4586	0
M	Cosine	Sine	Cotan.	Tan.	Cosec.	Secant	M

24° Natural Trigonometric Functions

M	Sine	Cosine	Tan.	Cotan.	Secant	Cosec.	M
0	0.40674	0.91354	0.44523	2.2460	1.0946	2.4586	60
1	.40700	.91343	.44558	.2443	.0948	.4570	59
2	.40727	.91331	.44593	.2425	.0949	.4554	58
3	.40753	.91319	.44627	.2408	.0951	.4538	57
4	.40780	.91307	.44662	.2390	.0952	.4522	56
5	0.40806	0.91295	0.44697	2.2373	1.0953	2.4506	55
6	.40833	.91283	.44732	.2355	.0955	.4490	54
7	.40860	.91271	.44767	.2338	.0956	.4474	53
8	.40886	.91260	.44802	.2320	.0958	.4458	52
9	.40913	.91248	.44837	.2303	.0959	.4442	51
10	0.40939	0.91236	0.44872	2.2286	1.0961	2.4426	50
11	.40966	.91224	.44907	.2268	.0962	.4411	49
12	.40992	.91212	.44942	.2251	.0963	.4395	48
13	.41019	.91200	.44977	.2234	.0965	.4379	47
14	.41045	.91188	.45012	.2216	.0966	.4363	46
15	0.41072	0.91176	0.45047	2.2199	1.0968	2.4347	45
16	.41098	.91164	.45082	.2182	.0969	.4332	44
17	.41125	.91152	.45117	.2165	.0971	.4316	43
18	.41151	.91140	.45152	.2147	.0972	.4300	42
19	.41178	.91128	.45187	.2130	.0973	.4285	41
20	0.41204	0.91116	0.45222	2.2113	1.0975	2.4269	40
21	.41231	.91104	.45257	.2096	.0976	.4254	39
22	.41257	.91092	.45292	.2079	.0978	.4238	38
23	.41284	.91080	.45327	.2062	.0979	.4222	37
24	.41310	.91068	.45362	.2045	.0981	.4207	36
25	0.41337	0.91056	0.45397	2.2028	1.0982	2.4191	35
26	.41363	.91044	.45432	.2011	.0984	.4176	34
27	.41390	.91032	.45467	.1994	.0985	.4160	33
28	.41416	.91020	.45502	.1977	.0986	.4145	32
29	.41443	.91008	.45537	.1960	.0988	.4130	31
30	0.41469	0.90996	0.45573	2.1943	1.0989	2.4114	30
31	.41496	.90984	.45608	.1926	.0991	.4099	29
32	.41522	.90972	.45643	.1909	.0992	.4083	28
33	.41549	.90960	.45678	.1892	.0994	.4068	27
34	.41575	.90948	.45713	.1875	.0995	.4053	26
35	0.41602	0.90936	0.45748	2.1859	1.0997	2.4037	25
36	.41628	.90924	.45783	.1842	.0998	.4022	24
37	.41654	.90911	.45819	.1825	.1000	.4007	23
38	.41681	.90899	.45854	.1808	.1001	.3992	22
39	.41707	.90887	.45889	.1792	.1003	.3976	21
40	0.41734	0.90875	0.45924	2.1775	1.1004	2.3961	20
41	.41760	.90863	.45960	.1758	.1005	.3946	19
42	.41787	.90851	.45995	.1741	.1007	.3931	18
43	.41813	.90839	.46030	.1725	.1008	.3916	17
44	.41839	.90826	.46065	.1708	.1010	.3901	16
45	0.41866	0.90814	0.46101	2.1692	1.1011	2.3886	15
46	.41892	.90802	.46136	.1675	.1013	.3871	14
47	.41919	.90790	.46171	.1658	.1014	.3856	13
48	.41945	.90778	.46206	.1642	.1016	.3841	12
49	.41972	.90765	.46242	.1625	.1017	.3826	11
50	0.41998	0.90753	0.46277	2.1609	1.1019	2.3811	10
51	.42024	.90741	.46312	.1592	.1020	.3796	9
52	.42051	.90729	.46348	.1576	.1022	.3781	8
53	.42077	.90717	.46383	.1559	.1023	.3766	7
54	.42103	.90704	.46418	.1543	.1025	.3751	6
55	0.42130	0.90692	0.46454	2.1527	1.1026	2.3736	5
56	.42156	.90680	.46489	.1510	.1028	.3721	4
57	.42183	.90668	.46524	.1494	.1029	.3706	3
58	.42209	.90655	.46560	.1478	.1031	.3691	2
59	.42235	.90643	.46595	.1461	.1032	.3677	1
60	0.42262	0.90631	0.46631	2.1445	1.1034	2.3662	0
M	Cosine	Sine	Cotan.	Tan.	Cosec.	Secant	M

65°

## 25° Natural Trigonometric Functions

M	Sine	Cosine	Tan.	Cotan.	Secant	Cosec.	M
0	0.42262	0.90631	0.46631	2.1445	1.1034	2.3662	60
1	.42288	.90618	.46666	.1429	.1035	.3647	59
2	.42314	.90606	.46702	.1412	.1037	.3632	58
3	.42341	.90594	.46737	.1396	.1038	.3618	57
4	.42367	.90581	.46772	.1380	.1040	.3603	56
5	0.42394	0.90569	0.46808	2.1364	1.1041	2.3588	55
6	.42420	.90557	.46843	.1348	.1043	.3574	54
7	.42446	.90544	.46879	.1331	.1044	.3559	53
8	.42473	.90532	.46914	.1315	.1046	.3544	52
9	.42499	.90520	.46950	.1299	.1047	.3530	51
10	0.42525	0.90507	0.46985	2.1283	1.1049	2.3515	50
11	.42552	.90495	.47021	.1267	.1050	.3501	49
12	.42578	.90483	.47056	.1251	.1052	.3486	48
13	.42604	.90470	.47092	.1235	.1053	.3472	47
14	.42630	.90458	.47127	.1219	.1055	.3457	46
15	0.42657	0.90445	0.47163	2.1203	1.1056	2.3443	45
16	.42683	.90433	.47199	.1187	.1058	.3428	44
17	.42709	.90421	.47234	.1171	.1059	.3414	43
18	.42736	.90408	.47270	.1155	.1061	.3399	42
19	.42762	.90396	.47305	.1139	.1062	.3385	41
20	0.42788	0.90383	0.47341	2.1123	1.1064	2.3371	40
21	.42815	.90371	.47376	.1107	.1065	.3356	39
22	.42841	.90358	.47412	.1092	.1067	.3342	38
23	.42867	.90346	.47448	.1076	.1068	.3328	37
24	.42893	.90333	.47483	.1060	.1070	.3313	36
25	0.42920	0.90321	0.47519	2.1044	1.1072	2.3299	35
26	.42946	.90308	.47555	.1028	.1073	.3285	34
27	.42972	.90296	.47590	.1013	.1075	.3271	33
28	.42998	.90283	.47626	.0997	.1076	.3256	32
29	.43025	.90271	.47662	.0981	.1078	.3242	31
30	0.43051	0.90258	0.47697	2.0965	1.1079	2.3228	30
31	.43077	.90246	.47733	.0950	.1081	.3214	29
32	.43104	.90233	.47769	.0934	.1082	.3200	28
33	.43130	.90221	.47805	.0918	.1084	.3186	27
34	.43156	.90208	.47840	.0903	.1085	.3172	26
35	0.43182	0.90196	0.47876	2.0887	1.1087	2.3158	25
36	.43208	.90183	.47912	.0872	.1088	.3143	24
37	.43235	.90171	.47948	.0856	.1090	.3129	23
38	.43261	.90158	.47983	.0840	.1092	.3115	22
39	.43287	.90145	.48019	.0825	.1093	.3101	21
40	0.43313	0.90133	0.48055	2.0809	1.1095	2.3087	20
41	.43340	.90120	.48091	.0794	.1096	.3073	19
42	.43366	.90108	.48127	.0778	.1098	.3059	18
43	.43392	.90095	.48162	.0763	.1099	.3046	17
44	.43418	.90082	.48198	.0747	.1101	.3032	16
45	0.43444	0.90070	0.48234	2.0732	1.1102	2.3018	15
46	.43471	.90057	.48270	.0717	.1104	.3004	14
47	.43497	.90044	.48306	.0701	.1106	.2990	13
48	.43523	.90032	.48342	.0686	.1107	.2976	12
49	.43549	.90019	.48378	.0671	.1109	.2962	11
50	0.43575	0.90006	0.48414	2.0655	1.1110	2.2949	10
51	.43602	.89994	.48449	.0640	.1112	.2935	9
52	.43628	.89981	.48485	.0625	.1113	.2921	8
53	.43654	.89968	.48521	.0609	.1115	.2907	7
54	.43680	.89956	.48557	.0594	.1116	.2894	6
55	0.43706	0.89943	0.48593	2.0579	1.1118	2.2880	5
56	.43732	.89930	.48629	.0564	.1120	.2866	4
57	.43759	.89918	.48665	.0548	.1121	.2853	3
58	.43785	.89905	.48701	.0533	.1123	.2839	2
59	.43811	.89892	.48737	.0518	.1124	.2825	1
60	0.43837	0.89879	0.48773	2.0503	1.1126	2.2812	0
M	Cosine	Sine	Cotan.	Tan.	Cosec.	Secant	M

26° Natural Trigonometric Functions

M	Sine	Cosine	Tan.	Cotan.	Secant	Cosec.	M
0	0.43837	0.89879	0.48773	2.0503	I.1126	2.2812	60
1	.43863	.89867	.48809	.0488	.1127	.2798	59
2	.43889	.89854	.48845	.0473	.1129	.2784	58
3	.43915	.89841	.48881	.0458	.1131	.2771	57
4	.43942	.89828	.48917	.0443	.1132	.2757	56
5	0.43968	0.89815	0.48953	2.0427	I.1134	2.2744	55
6	.43994	.89803	.48989	.0412	.1135	.2730	54
7	.44020	.89790	.49025	.0397	.1137	.2717	53
8	.44046	.89777	.49062	.0382	.1139	.2703	52
9	.44072	.89764	.49098	.0367	.1140	.2690	51
10	0.44098	0.89751	0.49134	2.0352	I.1142	2.2676	50
11	.44124	.89739	.49170	.0338	.1143	.2663	49
12	.44150	.89726	.49206	.0323	.1145	.2650	48
13	.44177	.89713	.49242	.0308	.1147	.2636	47
14	.44203	.89700	.49278	.0293	.1148	.2623	46
15	0.44229	0.89687	0.49314	2.0278	I.1150	2.2610	45
16	.44255	.89674	.49351	.0263	.1151	.2596	44
17	.44281	.89661	.49387	.0248	.1153	.2583	43
18	.44307	.89649	.49423	.0233	.1155	.2570	42
19	.44333	.89636	.49459	.0219	.1156	.2556	41
20	0.44359	0.89623	0.49495	2.0204	I.1158	2.2543	40
21	.44385	.89610	.49532	.0189	.1159	.2530	39
22	.44411	.89597	.49568	.0174	.1161	.2517	38
23	.44437	.89584	.49604	.0159	.1163	.2503	37
24	.44463	.89571	.49640	.0145	.1164	.2490	36
25	0.44489	0.89558	0.49677	2.0130	I.1166	2.2477	35
26	.44516	.89545	.49713	.0115	.1167	.2464	34
27	.44542	.89532	.49749	.0101	.1169	.2451	33
28	.44568	.89519	.49785	.0086	.1171	.2438	32
29	.44594	.89506	.49822	.0071	.1172	.2425	31
30	0.44620	0.89493	0.49858	2.0057	I.1174	2.2411	30
31	.44646	.89480	.49894	.0042	.1176	.2398	29
32	.44672	.89467	.49931	.0028	.1177	.2385	28
33	.44698	.89454	.49967	.0013	.1179	.2372	27
34	.44724	.89441	.50003	I.9998	.1180	.2359	26
35	0.44750	0.89428	0.50040	I.9984	I.1182	2.2346	25
36	.44776	.89415	.50076	.9969	.1184	.2333	24
37	.44802	.89402	.50113	.9955	.1185	.2320	23
38	.44828	.89389	.50149	.9940	.1187	.2307	22
39	.44854	.89376	.50185	.9926	.1189	.2294	21
40	0.44880	0.89363	0.50222	I.9912	I.1190	2.2282	20
41	.44906	.89350	.50258	.9897	.1192	.2269	19
42	.44932	.89337	.50295	.9883	.1193	.2256	18
43	.44958	.89324	.50331	.9868	.1195	.2243	17
44	.44984	.89311	.50368	.9854	.1197	.2230	16
45	0.45010	0.89298	0.50404	I.9840	I.1198	2.2217	15
46	.45036	.89285	.50441	.9825	.1200	.2204	14
47	.45062	.89272	.50477	.9811	.1202	.2192	13
48	.45088	.89258	.50514	.9797	.1203	.2179	12
49	.45114	.89245	.50550	.9782	.1205	.2166	11
50	0.45140	0.89232	0.50587	I.9768	I.1207	2.2153	10
51	.45166	.89219	.50623	.9754	.1208	.2141	9
52	.45191	.89206	.50660	.9739	.1210	.2128	8
53	.45217	.89193	.50696	.9725	.1212	.2115	7
54	.45243	.89180	.50733	.9711	.1213	.2103	6
55	0.45269	0.89166	0.50769	I.9697	I.1215	2.2090	5
56	.45295	.89153	.50806	.9683	.1217	.2077	4
57	.45321	.89140	.50843	.9668	.1218	.2065	3
58	.45347	.89127	.50879	.9654	.1220	.2052	2
59	.45373	.89114	.50916	.9640	.1222	.2039	1
60	0.45399	0.89101	0.50952	I.9626	I.1223	2.2027	0
M	Cosine	Sine	Cotan.	Tan.	Cosec.	Secant	M

## 27° Natural Trigonometric Functions

M	Sine	Cosine	Tan.	Cotan.	Secant	Cosec.	M
0	0.45399	0.89101	0.50952	1.9626	1.1223	2.2027	60
1	.45425	.89087	.50989	.9612	.1225	.2014	59
2	.45451	.89074	.51026	.9598	.1226	.2002	58
3	.45477	.89061	.51062	.9584	.1228	.1989	57
4	.45503	.89048	.51099	.9570	.1230	.1977	56
5	0.45528	0.89034	0.51136	1.9556	1.1231	2.1964	55
6	.45554	.89021	.51172	.9542	.1233	.1952	54
7	.45580	.89008	.51209	.9528	.1235	.1939	53
8	.45606	.88995	.51246	.9514	.1237	.1927	52
9	.45632	.88981	.51283	.9500	.1238	.1914	51
10	0.45658	0.88968	0.51319	1.9486	1.1240	2.1902	50
11	.45684	.88955	.51356	.9472	.1242	.1889	49
12	.45710	.88942	.51393	.9458	.1243	.1877	48
13	.45736	.88928	.51430	.9444	.1245	.1865	47
14	.45761	.88915	.51466	.9430	.1247	.1852	46
15	0.45787	0.88902	0.51503	1.9416	1.1248	2.1840	45
16	.45813	.88888	.51540	.9402	.1250	.1828	44
17	.45839	.88875	.51577	.9388	.1252	.1815	43
18	.45865	.88862	.51614	.9375	.1253	.1803	42
19	.45891	.88848	.51651	.9361	.1255	.1791	41
20	0.45917	0.88835	0.51687	1.9347	1.1257	2.1778	40
21	.45942	.88822	.51724	.9333	.1258	.1766	39
22	.45968	.88808	.51761	.9319	.1260	.1754	38
23	.45994	.88795	.51798	.9306	.1262	.1742	37
24	.46020	.88781	.51835	.9292	.1264	.1730	36
25	0.46046	0.88768	0.51872	1.9278	1.1265	2.1717	35
26	.46072	.88755	.51909	.9264	.1267	.1705	34
27	.46097	.88741	.51946	.9251	.1269	.1693	33
28	.46123	.88728	.51983	.9237	.1270	.1681	32
29	.46149	.88714	.52020	.9223	.1272	.1669	31
30	0.46175	0.88701	0.52057	1.9210	1.1274	2.1657	30
31	.46201	.88688	.52094	.9196	.1275	.1645	29
32	.46226	.88674	.52131	.9182	.1277	.1633	28
33	.46252	.88661	.52168	.9169	.1279	.1620	27
34	.46278	.88647	.52205	.9155	.1281	.1608	26
35	0.46304	0.88634	0.52242	1.9142	1.1282	2.1596	25
36	.46330	.88620	.52279	.9128	.1284	.1584	24
37	.46355	.88607	.52316	.9115	.1286	.1572	23
38	.46381	.88593	.52353	.9101	.1287	.1560	22
39	.46407	.88580	.52390	.9088	.1289	.1548	21
40	0.46433	0.88566	0.52427	1.9074	1.1291	2.1536	20
41	.46458	.88553	.52464	.9061	.1293	.1525	19
42	.46484	.88539	.52501	.9047	.1294	.1513	18
43	.46510	.88526	.52538	.9034	.1296	.1501	17
44	.46536	.88512	.52575	.9020	.1298	.1489	16
45	0.46561	0.88499	0.52612	1.9007	1.1299	2.1477	15
46	.46587	.88485	.52650	.8993	.1301	.1465	14
47	.46613	.88472	.52687	.8980	.1303	.1453	13
48	.46639	.88458	.52724	.8967	.1305	.1441	12
49	.46664	.88444	.52761	.8953	.1306	.1430	11
50	0.46690	0.88431	0.52798	1.8940	1.1308	2.1418	10
51	.46716	.88417	.52836	.8927	.1310	.1406	9
52	.46741	.88404	.52873	.8913	.1312	.1394	8
53	.46767	.88390	.52910	.8900	.1313	.1382	7
54	.46793	.88376	.52947	.8887	.1315	.1371	6
55	0.46819	0.88363	0.52984	1.8873	1.1317	2.1359	5
56	.46844	.88349	.53022	.8860	.1319	.1347	4
57	.46870	.88336	.53059	.8847	.1320	.1335	3
58	.46896	.88322	.53096	.8834	.1322	.1324	2
59	.46921	.88308	.53134	.8820	.1324	.1312	1
60	0.46947	0.88295	0.53171	1.8807	1.1326	2.1300	0
M	Cosine	Sine	Cotan.	Tan.	Cosec.	Secant	M

28° Natural Trigonometric Functions

M	Sine	Cosine	Tan.	Cotan.	Secant	Cosec.	M
0	0.46947	0.88295	0.53171	1.8807	1.1326	2.1300	60
1	.46973	.88281	.53208	.8794	.1327	.1289	59
2	.46998	.88267	.53245	.8781	.1329	.1277	58
3	.47024	.88254	.53283	.8768	.1331	.1266	57
4	.47050	.88240	.53320	.8754	.1333	.1254	56
5	0.47075	0.88226	0.53358	1.8741	1.1334	2.1242	55
6	.47101	.88213	.53395	.8728	.1336	.1231	54
7	.47127	.88199	.53432	.8715	.1338	.1219	53
8	.47152	.88185	.53470	.8702	.1340	.1208	52
9	.47178	.88171	.53507	.8689	.1341	.1196	51
10	0.47204	0.88158	0.53545	1.8676	1.1343	2.1185	50
11	.47229	.88144	.53582	.8663	.1345	.1173	49
12	.47255	.88130	.53619	.8650	.1347	.1162	48
13	.47281	.88117	.53657	.8637	.1349	.1150	47
14	.47306	.88103	.53694	.8624	.1350	.1139	46
15	0.47332	0.88089	0.53732	1.8611	1.1352	2.1127	45
16	.47357	.88075	.53769	.8598	.1354	.1116	44
17	.47383	.88061	.53807	.8585	.1356	.1104	43
18	.47409	.88048	.53844	.8572	.1357	.1093	42
19	.47434	.88034	.53882	.8559	.1359	.1082	41
20	0.47460	0.88020	0.53919	1.8546	1.1361	2.1070	40
21	.47486	.88006	.53957	.8533	.1363	.1059	39
22	.47511	.87992	.53995	.8520	.1365	.1048	38
23	.47537	.87979	.54032	.8507	.1366	.1036	37
24	.47562	.87965	.54070	.8495	.1368	.1025	36
25	0.47588	0.87951	0.54107	1.8482	1.1370	2.1014	35
26	.47613	.87937	.54145	.8469	.1372	.1002	34
27	.47639	.87923	.54183	.8456	.1373	.0991	33
28	.47665	.87909	.54220	.8443	.1375	.0980	32
29	.47690	.87895	.54258	.8430	.1377	.0969	31
30	0.47716	0.87882	0.54295	1.8418	1.1379	2.0957	30
31	.47741	.87868	.54333	.8405	.1381	.0946	29
32	.47767	.87854	.54371	.8392	.1382	.0935	28
33	.47792	.87840	.54409	.8379	.1384	.0924	27
34	.47818	.87826	.54446	.8367	.1386	.0912	26
35	0.47844	0.87812	0.54484	1.8354	1.1388	2.0901	25
36	.47869	.87798	.54522	.8341	.1390	.0890	24
37	.47895	.87784	.54559	.8329	.1391	.0879	23
38	.47920	.87770	.54597	.8316	.1393	.0868	22
39	.47946	.87756	.54635	.8303	.1395	.0857	21
40	0.47971	0.87742	0.54673	1.8291	1.1397	2.0846	20
41	.47997	.87728	.54711	.8278	.1399	.0835	19
42	.48022	.87715	.54748	.8265	.1401	.0824	18
43	.48048	.87701	.54786	.8253	.1402	.0812	17
44	.48073	.87687	.54824	.8240	.1404	.0801	16
45	0.48099	0.87673	0.54862	1.8227	1.1406	2.0790	15
46	.48124	.87659	.54900	.8215	.1408	.0779	14
47	.48150	.87645	.54937	.8202	.1410	.0768	13
48	.48175	.87631	.54975	.8190	.1411	.0757	12
49	.48201	.87617	.55013	.8177	.1413	.0746	11
50	0.48226	0.87603	0.55051	1.8165	1.1415	2.0735	10
51	.48252	.87588	.55089	.8152	.1417	.0725	9
52	.48277	.87574	.55127	.8140	.1419	.0714	8
53	.48303	.87560	.55165	.8127	.1421	.0703	7
54	.48328	.87546	.55203	.8115	.1422	.0692	6
55	0.48354	0.87532	0.55241	1.8102	1.1424	2.0681	5
56	.48379	.87518	.55279	.8090	.1426	.0670	4
57	.48405	.87504	.55317	.8078	.1428	.0659	3
58	.48430	.87490	.55355	.8065	.1430	.0648	2
59	.48455	.87476	.55393	.8053	.1432	.0637	1
60	0.48481	0.87462	0.55431	1.8040	1.1433	2.0627	0
M	Cosine	Sine	Cotan.	Tan.	Cosec.	Secant	M



M	Sine	Cosine	Tan.	Cotan.	Secant	Cosec.	M
0	0.48481	0.87462	0.55431	1.8040	1.1433	2.0627	60
1	.48506	.87448	.55469	.8028	.1435	.0616	59
2	.48532	.87434	.55507	.8016	.1437	.0605	58
3	.48557	.87420	.55545	.8003	.1439	.0594	57
4	.48583	.87405	.55583	.7991	.1441	.0583	56
5	0.48608	0.87391	0.55621	1.7979	1.1443	2.0573	55
6	.48633	.87377	.55659	.7966	.1445	.0562	54
7	.48659	.87363	.55697	.7954	.1446	.0551	53
8	.48684	.87349	.55735	.7942	.1448	.0540	52
9	.48710	.87335	.55774	.7930	.1450	.0530	51
10	0.48735	0.87320	0.55812	1.7917	1.1452	2.0519	50
11	.48760	.87306	.55850	.7905	.1454	.0508	49
12	.48786	.87292	.55888	.7893	.1456	.0498	48
13	.48811	.87278	.55926	.7881	.1458	.0487	47
14	.48837	.87264	.55964	.7868	.1459	.0476	46
15	0.48862	0.87250	0.56003	1.7856	1.1461	2.0466	45
16	.48887	.87235	.56041	.7844	.1463	.0455	44
17	.48913	.87221	.56079	.7832	.1465	.0444	43
18	.48938	.87207	.56117	.7820	.1467	.0434	42
19	.48964	.87193	.56156	.7808	.1469	.0423	41
20	0.48989	0.87178	0.56194	1.7795	1.1471	2.0413	40
21	.49014	.87164	.56232	.7783	.1473	.0402	39
22	.49040	.87150	.56270	.7771	.1474	.0392	38
23	.49065	.87136	.56309	.7759	.1476	.0381	37
24	.49090	.87121	.56347	.7747	.1478	.0370	36
25	0.49116	0.87107	0.56385	1.7735	1.1480	2.0360	35
26	.49141	.87093	.56424	.7723	.1482	.0349	34
27	.49166	.87078	.56462	.7711	.1484	.0339	33
28	.49192	.87064	.56500	.7699	.1486	.0329	32
29	.49217	.87050	.56539	.7687	.1488	.0318	31
30	0.49242	0.87035	0.56577	1.7675	1.1489	2.0308	30
31	.49268	.87021	.56616	.7663	.1491	.0297	29
32	.49293	.87007	.56654	.7651	.1493	.0287	28
33	.49318	.86992	.56692	.7639	.1495	.0276	27
34	.49343	.86978	.56731	.7627	.1497	.0266	26
35	0.49369	0.86964	0.56769	1.7615	1.1499	2.0256	25
36	.49394	.86949	.56808	.7603	.1501	.0245	24
37	.49419	.86935	.56846	.7591	.1503	.0235	23
38	.49445	.86921	.56885	.7579	.1505	.0224	22
39	.49470	.86906	.56923	.7567	.1507	.0214	21
40	0.49495	0.86892	0.56962	1.7555	1.1508	2.0204	20
41	.49521	.86877	.57000	.7544	.1510	.0194	19
42	.49546	.86863	.57039	.7532	.1512	.0183	18
43	.49571	.86849	.57077	.7520	.1514	.0173	17
44	.49596	.86834	.57116	.7508	.1516	.0163	16
45	0.49622	0.86820	0.57155	1.7496	1.1518	2.0152	15
46	.49647	.86805	.57193	.7484	.1520	.0142	14
47	.49672	.86791	.57232	.7473	.1522	.0132	13
48	.49697	.86776	.57270	.7461	.1524	.0122	12
49	.49723	.86762	.57309	.7449	.1526	.0111	11
50	0.49748	0.86748	0.57348	1.7437	1.1528	2.0101	10
51	.49773	.86733	.57386	.7426	.1530	.0091	9
52	.49798	.86719	.57425	.7414	.1531	.0081	8
53	.49823	.86704	.57464	.7402	.1533	.0071	7
54	.49849	.86690	.57503	.7390	.1535	.0061	6
55	0.49874	0.86675	0.57541	1.7379	1.1537	2.0050	5
56	.49899	.86661	.57580	.7367	.1539	.0040	4
57	.49924	.86646	.57619	.7355	.1541	.0030	3
58	.49950	.86632	.57657	.7344	.1543	.0020	2
59	.49975	.86617	.57696	.7332	.1545	.0010	1
60	0.50000	0.86603	0.57735	1.7320	1.1547	2.0000	0
M	Cosine	Sine	Cotan.	Tan.	Cosec.	Secant	M

M	Sine	Cosine	Tan.	Cotan.	Secant	Cosec.	M
0	0.50000	0.86603	0.57735	1.7320	1.1547	2.0000	60
1	.50025	.86588	.57774	.7309	.1549	1.9990	59
2	.50050	.86573	.57813	.7297	.1551	.9980	58
3	.50075	.86559	.57851	.7286	.1553	.9970	57
4	.50101	.86544	.57890	.7274	.1555	.9960	56
5	0.50126	0.86530	0.57929	1.7262	1.1557	1.9950	55
6	.50151	.86515	.57968	.7251	.1559	.9940	54
7	.50176	.86500	.53007	.7239	.1561	.9930	53
8	.50201	.86486	.58046	.7228	.1562	.9920	52
9	.50226	.86471	.58085	.7216	.1564	.9910	51
10	0.50252	0.86457	0.58123	1.7205	1.1566	1.9900	50
11	.50277	.86442	.58162	.7193	.1568	.9890	49
12	.50302	.86427	.58201	.7182	.1570	.9880	48
13	.50327	.86413	.58240	.7170	.1572	.9870	47
14	.50352	.86398	.58279	.7159	.1574	.9860	46
15	0.50377	0.86383	0.53318	1.7147	1.1576	1.9850	45
16	.50402	.86369	.53357	.7136	.1578	.9840	44
17	.50428	.86354	.58396	.7124	.1580	.9830	43
18	.50453	.86339	.58435	.7113	.1582	.9820	42
19	.50478	.86325	.58474	.7101	.1584	.9811	41
20	0.50503	0.86310	0.58513	1.7090	1.1586	1.9801	40
21	.50528	.86295	.58552	.7079	.1588	.9791	39
22	.50553	.86281	.58591	.7067	.1590	.9781	38
23	.50578	.86266	.58630	.7056	.1592	.9771	37
24	.50603	.86251	.58670	.7044	.1594	.9761	36
25	0.50628	0.86237	0.58709	1.7033	1.1596	1.9752	35
26	.50653	.86222	.58748	.7022	.1598	.9742	34
27	.50679	.86207	.58787	.7010	.1600	.9732	33
28	.50704	.86192	.58826	.6999	.1602	.9722	32
29	.50729	.86177	.58865	.6988	.1604	.9713	31
30	0.50754	0.86163	0.58904	1.6977	1.1606	1.9703	30
31	.50779	.86148	.58944	.6965	.1608	.9693	29
32	.50804	.86133	.58983	.6954	.1610	.9683	28
33	.50829	.86118	.59022	.6943	.1612	.9674	27
34	.50854	.86104	.59061	.6931	.1614	.9664	26
35	0.50879	0.86089	0.59100	1.6920	1.1616	1.9654	25
36	.50904	.86074	.59140	.6909	.1618	.9645	24
37	.50929	.86059	.59179	.6898	.1620	.9635	23
38	.50954	.86044	.59218	.6887	.1622	.9625	22
39	.50979	.86030	.59258	.6875	.1624	.9616	21
40	0.51004	0.86015	0.59297	1.6864	1.1626	1.9606	20
41	.51029	.86000	.59336	.6853	.1628	.9596	19
42	.51054	.85985	.59376	.6842	.1630	.9587	18
43	.51079	.85970	.59415	.6831	.1632	.9577	17
44	.51104	.85955	.59454	.6820	.1634	.9563	16
45	0.51129	0.85941	0.59494	1.6808	1.1636	1.9558	15
46	.51154	.85926	.59533	.6797	.1638	.9549	14
47	.51179	.85911	.59572	.6786	.1640	.9539	13
48	.51204	.85896	.59612	.6775	.1642	.9530	12
49	.51229	.85881	.59651	.6764	.1644	.9520	11
50	0.51254	0.85866	0.59691	1.6753	1.1646	1.9510	10
51	.51279	.85851	.59730	.6742	.1648	.9501	9
52	.51304	.85836	.59770	.6731	.1650	.9491	8
53	.51329	.85821	.59809	.6720	.1652	.9482	7
54	.51354	.85806	.59849	.6709	.1654	.9473	6
55	0.51379	0.85791	0.59888	1.6698	1.1656	1.9463	5
56	.51404	.85777	.59928	.6687	.1658	.9454	4
57	.51429	.85762	.59967	.6676	.1660	.9444	3
58	.51454	.85747	.60007	.6665	.1662	.9435	2
59	.51479	.85732	.60046	.6654	.1664	.9425	1
60	0.51504	0.85717	0.60086	1.6643	1.1666	1.9416	0

M	Cosine	Sine	Cotan.	Tan.	Cosec.	Secant	M
0	0.86603	0.50000	1.7320	0.57735	2.0000	1.1547	60
1	.86588	.50025	.7309	.57774	1.9990	.1549	59
2	.86573	.50050	.7297	.57813	.9980	.1551	58
3	.86559	.50075	.7286	.57851	.9970	.1553	57
4	.86544	.50101	.7274	.57890	.9960	.1555	56
5	0.86530	0.50126	1.7262	0.57929	1.9950	1.1557	55
6	.86515	.50151	.7251	.57968	.9940	.1559	54
7	.86500	.50176	.7239	.53007	.9930	.1561	53
8	.86486	.50201	.7228	.58046	.9920	.1562	52
9	.86471	.50226	.7216	.58085	.9910	.1564	51
10	0.86457	0.50252	1.7205	0.58123	1.9900	1.1566	50
11	.86442	.50277	.7193	.58162	.9890	.1568	49
12	.86427	.50302	.7182	.58201	.9880	.1570	48
13	.86413	.50327	.7170	.58240	.9870	.1572	47
14	.86398	.50352	.7159	.58279	.9860	.1574	46
15	0.86383	0.50377	1.7147	0.53318	1.9850	1.1576	45
16	.86369	.50402	.7136	.53357	.9840	.1578	44
17	.86354	.50428	.7124	.58396	.9830	.1580	43
18	.86339	.50453	.7113	.58435	.9820	.1582	42
19	.86325	.50478	.7101	.58474	.9811	.1584	41
20	0.86310	0.50503	1.7090	0.58513	1.9801	1.1586	40
21	.86295	.50528	.7079	.58552	.9791	.1588	39
22	.86281	.50553	.7067	.58591	.9781	.1590	38
23	.86266	.50578	.7056	.58630	.9771	.1592	37
24	.86251	.50603	.7044	.58670	.9761	.1594	36
25	0.86237	0.50628	1.7033	0.58709	1.9752	1.1596	35
26	.86222	.50653	.7022	.58748	.9742	.1598	34
27	.86207	.50679	.7010	.58787	.9732	.1600	33
28	.86192	.50704	.6999	.58826	.9722	.1602	32
29	.86177	.50729	.6988	.58865	.9713	.1604	31
30	0.86163	0.50754	1.6977	0.58904	1.9703	1.1606	30
31	.86148	.50779	.6965	.58944	.9693	.1608	29
32	.86133	.50804	.6954	.58983	.9683	.1610	28
33	.86118	.50829	.6943	.59022	.9674	.1612	27
34	.86104	.50854	.6931	.59061	.9664	.1614	26
35	0.86089	0.50879	1.6920	0.59100	1.9654	1.1616	25
36	.86074	.50904	.6909	.59140	.9645	.1618	24
37	.86059	.50929	.6898	.59179	.9635	.1620	23
38	.86044	.50954	.6887	.59218	.9625	.1622	22
39	.86030	.50979	.6875	.59258	.9616	.1624	21
40	0.86015	0.51004	1.6864	0.59297	1.9606	1.1626	20
41	.86000	.51029	.6853	.59336	.9596	.1628	19
42	.85985	.51054	.6842	.59376	.9587	.1630	18
43	.85970	.51079	.6831	.59415	.9577	.1632	17
44	.85955	.51104	.6820	.59454	.9563	.1634	16
45	0.85941	0.51129	1.6808	0.59494	1.9558	1.1636	15
46	.85926	.51154	.6797	.59533	.9549	.1638	14
47	.85911	.51179	.6786	.59572	.9539	.1640	13
48	.85896	.51204	.6775	.59612	.9530	.1642	12
49	.85881	.51229	.6764	.59651	.9520	.1644	11
50	0.85866	0.51254	1.6753	0.59691	1.9510	1.1646	10
51	.85851	.51279	.6742	.59730	.9501	.1648	9
52	.85836	.51304	.6731	.59770	.9491	.1650	8
53	.85821	.51329	.6720	.59809	.9482	.1652	7
54	.85806	.51354	.6709	.59849	.9473	.1654	6
55	0.85791	0.51379	1.6698	0.59888	1.9463	1.1656	5
56	.85777	.51404	.6687	.59928	.9454	.1658	4
57	.85762	.51429	.6676	.59967	.9444	.1660	3
58	.85747	.51454	.6665	.60007	.9435	.1662	2
59	.85732	.51479	.6654	.60046	.9425	.1664	1
60	0.85717	0.51504	1.6643	0.60086	1.9416	1.1666	0

# 31° Natural Trigonometric Functions

M	Sine	Cosine	Tan.	Cotan.	Secant	Cosec.	M
0	0.51504	0.85717	0.60086	I.6643	I.1666	I.9416	60
1	.51529	.85702	.60126	.6632	.1668	.9407	59
2	.51554	.85687	.60165	.6621	.1670	.9397	58
3	.51578	.85672	.60205	.6610	.1672	.9388	57
4	.51603	.85657	.60244	.6599	.1674	.9378	56
5	0.51628	0.85642	0.60284	I.6588	I.1676	I.9369	55
6	.51653	.85627	.60324	.6577	.1678	.9360	54
7	.51678	.85612	.60363	.6566	.1681	.9350	53
8	.51703	.85597	.60403	.6555	.1683	.9341	52
9	.51728	.85582	.60443	.6544	.1685	.9332	51
10	0.51753	0.85566	0.60483	I.6534	I.1687	I.9322	50
11	.51778	.85551	.60522	.6523	.1689	.9313	49
12	.51803	.85536	.60562	.6512	.1691	.9304	48
13	.51827	.85521	.60602	.6501	.1693	.9295	47
14	.51852	.85506	.60642	.6490	.1695	.9285	46
15	0.51877	0.85491	0.60681	I.6479	I.1697	I.9276	45
16	.51902	.85476	.60721	.6469	.1699	.9267	44
17	.51927	.85461	.60761	.6458	.1701	.9258	43
18	.51952	.85446	.60801	.6447	.1703	.9248	42
19	.51977	.85431	.60841	.6436	.1705	.9239	41
20	0.52002	0.85416	0.60881	I.6425	I.1707	I.9230	40
21	.52026	.85400	.60920	.6415	.1709	.9221	39
22	.52051	.85385	.60960	.6404	.1712	.9212	38
23	.52076	.85370	.61000	.6393	.1714	.9203	37
24	.52101	.85355	.61040	.6383	.1716	.9193	36
25	0.52126	0.85340	0.61080	I.6372	I.1718	I.9184	35
26	.52151	.85325	.61120	.6361	.1720	.9175	34
27	.52175	.85309	.61160	.6350	.1722	.9166	33
28	.52200	.85294	.61200	.6340	.1724	.9157	32
29	.52225	.85279	.61240	.6329	.1726	.9148	31
30	0.52250	0.85264	0.61280	I.6318	I.1728	I.9139	30
31	.52275	.85249	.61320	.6308	.1730	.9130	29
32	.52299	.85234	.61360	.6297	.1732	.9121	28
33	.52324	.85218	.61400	.6286	.1734	.9112	27
34	.52349	.85203	.61440	.6276	.1737	.9102	26
35	0.52374	0.85188	0.61480	I.6265	I.1739	I.9093	25
36	.52398	.85173	.61520	.6255	.1741	.9084	24
37	.52423	.85157	.61560	.6244	.1743	.9075	23
38	.52448	.85142	.61601	.6233	.1745	.9066	22
39	.52473	.85127	.61641	.6223	.1747	.9057	21
40	0.52498	0.85112	0.61681	I.6212	I.1749	I.9048	20
41	.52522	.85096	.61721	.6202	.1751	.9039	19
42	.52547	.85081	.61761	.6191	.1753	.9030	18
43	.52572	.85066	.61801	.6181	.1756	.9021	17
44	.52597	.85050	.61842	.6170	.1758	.9013	16
45	0.52621	0.85035	0.61882	I.6160	I.1760	I.9004	15
46	.52646	.85020	.61922	.6149	.1762	.8995	14
47	.52671	.85004	.61962	.6139	.1764	.8986	13
48	.52695	.84989	.62003	.6128	.1766	.8977	12
49	.52720	.84974	.62043	.6118	.1768	.8968	11
50	0.52745	0.84959	0.62083	I.6107	I.1770	I.8959	10
51	.52770	.84943	.62123	.6097	.1772	.8950	9
52	.52794	.84928	.62164	.6086	.1775	.8941	8
53	.52819	.84912	.62204	.6076	.1777	.8932	7
54	.52844	.84897	.62244	.6066	.1779	.8924	6
55	0.52868	0.84882	0.62285	I.6055	I.1781	I.8915	5
56	.52893	.84866	.62325	.6045	.1783	.8906	4
57	.52918	.84851	.62366	.6034	.1785	.8897	3
58	.52942	.84836	.62406	.6024	.1787	.8888	2
59	.52967	.84820	.62446	.6014	.1790	.8879	1
60	0.52992	0.84805	0.62487	I.6003	I.1792	I.8871	C

M	Cosine	Sine	Cotan.	Tan.	Cosec.	Secant	M
---	--------	------	--------	------	--------	--------	---

# 32° Natural Trigonometric Functions

M	Sine	Cosine	Tan.	Cotan.	Secant	Cosec.	M
0	0.52992	0.84805	0.62487	1.6003	1.1792	1.8871	60
1	.53016	.84789	.62527	.5993	.1794	.8862	59
2	.53041	.84774	.62568	.5983	.1796	.8853	58
3	.53066	.84758	.62608	.5972	.1798	.8844	57
4	.53090	.84743	.62649	.5962	.1800	.8836	56
5	0.53115	0.84728	0.62689	1.5952	1.1802	1.8827	55
6	.53140	.84712	.62730	.5941	.1805	.8818	54
7	.53164	.84697	.62770	.5931	.1807	.8809	53
8	.53189	.84681	.62811	.5921	.1809	.8801	52
9	.53214	.84666	.62851	.5910	.1811	.8792	51
10	0.53238	0.84650	0.62892	1.5900	1.1813	1.8783	50
11	.53263	.84635	.62933	.5890	.1815	.8775	49
12	.53288	.84619	.62973	.5880	.1818	.8766	48
13	.53312	.84604	.63014	.5869	.1820	.8757	47
14	.53337	.84588	.63055	.5859	.1822	.8749	46
15	0.53361	0.84573	0.63095	1.5849	1.1824	1.8740	45
16	.53386	.84557	.63136	.5839	.1826	.8731	44
17	.53411	.84542	.63177	.5829	.1828	.8723	43
18	.53435	.84526	.63217	.5818	.1831	.8714	42
19	.53460	.84511	.63258	.5808	.1833	.8706	41
20	0.53484	0.84495	0.63299	1.5798	1.1835	1.8697	40
21	.53509	.84479	.63339	.5788	.1837	.8688	39
22	.53533	.84464	.63380	.5778	.1839	.8680	38
23	.53558	.84448	.63421	.5768	.1841	.8671	37
24	.53583	.84433	.63462	.5757	.1844	.8663	36
25	0.53607	0.84417	0.63503	1.5747	1.1846	1.8654	35
26	.53632	.84402	.63543	.5737	.1848	.8646	34
27	.53656	.84386	.63584	.5727	.1850	.8637	33
28	.53681	.84370	.63625	.5717	.1852	.8629	32
29	.53705	.84355	.63666	.5707	.1855	.8620	31
30	0.53730	0.84339	0.63707	1.5697	1.1857	1.8611	30
31	.53754	.84323	.63748	.5687	.1859	.8603	29
32	.53779	.84308	.63789	.5677	.1861	.8595	28
33	.53803	.84292	.63830	.5667	.1863	.8586	27
34	.53828	.84276	.63871	.5657	.1866	.8578	26
35	0.53852	0.84261	0.63912	1.5646	1.1868	1.8569	25
36	.53877	.84245	.63953	.5636	.1870	.8561	24
37	.53901	.84229	.63994	.5626	.1872	.8552	23
38	.53926	.84214	.64035	.5616	.1874	.8544	22
39	.53950	.84193	.64076	.5606	.1877	.8535	21
40	0.53975	0.84182	0.64117	1.5596	1.1879	1.8527	20
41	.53999	.84167	.64158	.5586	.1881	.8519	19
42	.54024	.84151	.64199	.5577	.1883	.8510	18
43	.54048	.84135	.64240	.5567	.1886	.8502	17
44	.54073	.84120	.64281	.5557	.1888	.8493	16
45	0.54097	0.84104	0.64322	1.5547	1.1890	1.8485	15
46	.54122	.84088	.64363	.5537	.1892	.8477	14
47	.54146	.84072	.64404	.5527	.1894	.8468	13
48	.54171	.84057	.64446	.5517	.1897	.8460	12
49	.54195	.84041	.64487	.5507	.1899	.8452	11
50	0.54220	0.84025	0.64528	1.5497	1.1901	1.8443	10
51	.54244	.84009	.64569	.5487	.1903	.8435	9
52	.54268	.83993	.64610	.5477	.1906	.8427	8
53	.54293	.83978	.64652	.5467	.1908	.8418	7
54	.54317	.83962	.64693	.5458	.1910	.8410	6
55	0.54342	0.83946	0.64734	1.5448	1.1912	1.8402	5
56	.54366	.83930	.64775	.5438	.1915	.8394	4
57	.54391	.83914	.64817	.5428	.1917	.8385	3
58	.54415	.83899	.64858	.5418	.1919	.8377	2
59	.54439	.83883	.64899	.5408	.1921	.8369	1
60	0.54464	0.83867	0.64941	1.5399	1.1924	1.8361	0
M	Cosine	Sine	Cotan.	Tan.	Cosec.	Secant	M

M	Sine	Cosine	Tan.	Cotan.	Secant	Cosec.	M
0	0.54464	0.83867	0.64941	1.5399	1.1924	1.8361	60
1	.54488	.83851	.64982	.5389	.1926	.8352	59
2	.54513	.83835	.65023	.5379	.1928	.8344	58
3	.54537	.83819	.65065	.5369	.1930	.8336	57
4	.54561	.83804	.65106	.5359	.1933	.8328	56
5	0.54586	0.83788	0.65148	1.5350	1.1935	1.8320	55
6	.54610	.83772	.65189	.5340	.1937	.8311	54
7	.54634	.83756	.65231	.5330	.1939	.8303	53
8	.54659	.83740	.65272	.5320	.1942	.8295	52
9	.54683	.83724	.65314	.5311	.1944	.8287	51
10	0.54708	0.83708	0.65355	1.5301	1.1946	1.8279	50
11	.54732	.83692	.65397	.5291	.1948	.8271	49
12	.54756	.83676	.65438	.5282	.1951	.8263	48
13	.54781	.83660	.65480	.5272	.1953	.8255	47
14	.54805	.83644	.65521	.5262	.1955	.8246	46
15	0.54829	0.83629	0.65563	1.5252	1.1958	1.8238	45
16	.54854	.83613	.65604	.5243	.1960	.8230	44
17	.54878	.83597	.65646	.5233	.1962	.8222	43
18	.54902	.83581	.65688	.5223	.1964	.8214	42
19	.54926	.83565	.65729	.5214	.1967	.8206	41
20	0.54951	0.83549	0.65771	1.5204	1.1969	1.8198	40
21	.54975	.83533	.65813	.5195	.1971	.8190	39
22	.54999	.83517	.65854	.5185	.1974	.8182	38
23	.55024	.83501	.65896	.5175	.1976	.8174	37
24	.55048	.83485	.65938	.5166	.1978	.8166	36
25	0.55072	0.83469	0.65980	1.5156	1.1980	1.8158	35
26	.55097	.83453	.66021	.5147	.1983	.8150	34
27	.55121	.83437	.66063	.5137	.1985	.8142	33
28	.55145	.83421	.66105	.5127	.1987	.8134	32
29	.55169	.83405	.66147	.5118	.1990	.8126	31
30	0.55194	0.83389	0.66188	1.5108	1.1992	1.8118	30
31	.55218	.83372	.66230	.5099	.1994	.8110	29
32	.55242	.83356	.66272	.5089	.1997	.8102	28
33	.55266	.83340	.66314	.5080	.1999	.8094	27
34	.55291	.83324	.66356	.5070	.2001	.8086	26
35	0.55315	0.83308	0.66398	1.5061	1.2004	1.8078	25
36	.55339	.83292	.66440	.5051	.2006	.8070	24
37	.55363	.83276	.66482	.5042	.2008	.8062	23
38	.55388	.83260	.66524	.5032	.2010	.8054	22
39	.55412	.83244	.66566	.5023	.2013	.8047	21
40	0.55436	0.83228	0.66608	1.5013	1.2015	1.8039	20
41	.55460	.83211	.66650	.5004	.2017	.8031	19
42	.55484	.83195	.66692	.4994	.2020	.8023	18
43	.55509	.83179	.66734	.4985	.2022	.8015	17
44	.55533	.83163	.66776	.4975	.2024	.8007	16
45	0.55557	0.83147	0.66818	1.4966	1.2027	1.7999	15
46	.55581	.83131	.66860	.4957	.2029	.7992	14
47	.55605	.83115	.66902	.4947	.2031	.7984	13
48	.55629	.83098	.66944	.4938	.2034	.7976	12
49	.55654	.83082	.66986	.4928	.2036	.7968	11
50	0.55678	0.83066	0.67028	1.4919	1.2039	1.7960	10
51	.55702	.83050	.67071	.4910	.2041	.7953	9
52	.55726	.83034	.67113	.4900	.2043	.7945	8
53	.55750	.83017	.67155	.4891	.2046	.7937	7
54	.55774	.83001	.67197	.4881	.2048	.7929	6
55	0.55799	0.82985	0.67239	1.4872	1.2050	1.7921	5
56	.55823	.82969	.67282	.4863	.2053	.7914	4
57	.55847	.82952	.67324	.4853	.2055	.7906	3
58	.55871	.82936	.67366	.4844	.2057	.7898	2
59	.55895	.82920	.67408	.4835	.2060	.7891	1
60	0.55919	0.82904	0.67451	1.4826	1.2062	1.7883	0
M	Cosine	Sine	Cotan.	Tan.	Cosec.	Secant	M

# 34° Natural Trigonometric Functions

M	Sine	Cosine	Tan.	Cotan.	Secant	Cosec.	M
0	0.55919	0.82904	0.67451	I.4826	I.2062	I.7883	60
1	.55943	.82887	.67493	.4816	.2064	.7875	59
2	.55967	.82871	.67535	.4807	.2067	.7867	58
3	.55992	.82855	.67578	.4798	.2069	.7860	57
4	.56016	.82839	.67620	.4788	.2072	.7852	56
5	0.56040	0.82822	0.67663	I.4779	I.2074	I.7844	55
6	.56064	.82806	.67705	.4770	.2076	.7837	54
7	.56088	.82790	.67747	.4761	.2079	.7829	53
8	.56112	.82773	.67790	.4751	.2081	.7821	52
9	.56136	.82757	.67832	.4742	.2083	.7814	51
10	0.56160	0.82741	0.67875	I.4733	I.2086	I.7806	50
11	.56184	.82724	.67917	.4724	.2088	.7798	49
12	.56208	.82708	.67960	.4714	.2091	.7791	48
13	.56232	.82692	.68002	.4705	.2093	.7783	47
14	.56256	.82675	.68045	.4696	.2095	.7776	46
15	0.56280	0.82659	0.68087	I.4687	I.2098	I.7768	45
16	.56304	.82643	.68130	.4678	.2100	.7760	44
17	.56328	.82626	.68173	.4669	.2103	.7753	43
18	.56353	.82610	.68215	.4659	.2105	.7745	42
19	.56377	.82593	.68258	.4650	.2107	.7738	41
20	0.56401	0.82577	0.68301	I.4641	I.2110	I.7730	40
21	.56425	.82561	.68343	.4632	.2112	.7723	39
22	.56449	.82544	.68386	.4623	.2115	.7715	38
23	.56473	.82528	.68429	.4614	.2117	.7708	37
24	.56497	.82511	.68471	.4605	.2119	.7700	36
25	0.56521	0.82495	0.68514	I.4595	I.2122	I.7693	35
26	.56545	.82478	.68557	.4586	.2124	.7685	34
27	.56569	.82462	.68600	.4577	.2127	.7678	33
28	.56593	.82445	.68642	.4568	.2129	.7670	32
29	.56617	.82429	.68685	.4559	.2132	.7663	31
30	0.56641	0.82413	0.68728	I.4550	I.2134	I.7655	30
31	.56664	.82396	.68771	.4541	.2136	.7648	29
32	.56688	.82380	.68814	.4532	.2139	.7640	28
33	.56712	.82363	.68857	.4523	.2141	.7633	27
34	.56736	.82347	.68899	.4514	.2144	.7625	26
35	0.56760	0.82330	0.68942	I.4505	I.2146	I.7618	25
36	.56784	.82314	.68985	.4496	.2149	.7610	24
37	.56808	.82297	.69028	.4487	.2151	.7603	23
38	.56832	.82280	.69071	.4478	.2153	.7596	22
39	.56856	.82264	.69114	.4469	.2156	.7588	21
40	0.56880	0.82247	0.69157	I.4460	I.2158	I.7581	20
41	.56904	.82231	.69200	.4451	.2161	.7573	19
42	.56928	.82214	.69243	.4442	.2163	.7566	18
43	.56952	.82198	.69286	.4433	.2166	.7559	17
44	.56976	.82181	.69329	.4424	.2168	.7551	16
45	0.57000	0.82165	0.69372	I.4415	I.2171	I.7544	15
46	.57023	.82148	.69415	.4406	.2173	.7537	14
47	.57047	.82131	.69459	.4397	.2175	.7529	13
48	.57071	.82115	.69502	.4388	.2178	.7522	12
49	.57095	.82098	.69545	.4379	.2180	.7514	11
50	0.57119	0.82082	0.69588	I.4370	I.2183	I.7507	10
51	.57143	.82065	.69631	.4361	.2185	.7500	9
52	.57167	.82048	.69674	.4352	.2188	.7493	8
53	.57191	.82032	.69718	.4343	.2190	.7485	7
54	.57214	.82015	.69761	.4335	.2193	.7478	6
55	0.57238	0.81998	0.69804	I.4326	I.2195	I.7471	5
56	.57262	.81982	.69847	.4317	.2198	.7463	4
57	.57286	.81965	.69891	.4308	.2200	.7456	3
58	.57310	.81948	.69934	.4299	.2203	.7449	2
59	.57334	.81932	.69977	.4290	.2205	.7442	1
60	0.57358	0.81915	0.70021	I.4281	I.2208	I.7434	0
M	Cosine	Sine	Cotan.	Tan.	Cosec.	Secant	M

# 35° Natural Trigonometric Functions

M	Sine	Cosine	Tan.	Cotan.	Secant	Cosec.	M
0	0.57358	0.81915	0.70021	I.4281	I.2208	I.7434	60
1	.57381	.81898	.70064	.4273	.2210	.7427	59
2	.57405	.81882	.70107	.4264	.2213	.7420	58
3	.57429	.81865	.70151	.4255	.2215	.7413	57
4	.57453	.81848	.70194	.4246	.2218	.7405	56
5	0.57477	0.81832	0.70238	I.4237	I.2220	I.7398	55
6	.57500	.81815	.70281	.4228	.2223	.7391	54
7	.57524	.81798	.70325	.4220	.2225	.7384	53
8	.57548	.81781	.70368	.4211	.2228	.7377	52
9	.57572	.81765	.70412	.4202	.2230	.7369	51
10	0.57596	0.81748	0.70455	I.4193	I.2233	I.7362	50
11	.57619	.81731	.70499	.4185	.2235	.7355	49
12	.57643	.81714	.70542	.4176	.2238	.7348	48
13	.57667	.81698	.70586	.4167	.2240	.7341	47
14	.57691	.81681	.70629	.4158	.2243	.7334	46
15	0.57714	0.81664	0.70673	I.4150	I.2245	I.7327	45
16	.57738	.81647	.70717	.4141	.2248	.7319	44
17	.57762	.81630	.70760	.4132	.2250	.7312	43
18	.57786	.81614	.70804	.4123	.2253	.7305	42
19	.57809	.81597	.70848	.4115	.2255	.7298	41
20	0.57833	0.81580	0.70891	I.4106	I.2258	I.7291	40
21	.57857	.81563	.70935	.4097	.2260	.7284	39
22	.57881	.81546	.70979	.4089	.2263	.7277	38
23	.57904	.81530	.71022	.4080	.2265	.7270	37
24	.57928	.81513	.71066	.4071	.2268	.7263	36
25	0.57952	0.81496	0.71110	I.4063	I.2270	I.7256	35
26	.57975	.81479	.71154	.4054	.2273	.7249	34
27	.57999	.81462	.71198	.4045	.2276	.7242	33
28	.58023	.81445	.71241	.4037	.2278	.7234	32
29	.58047	.81428	.71285	.4028	.2281	.7227	31
30	0.58070	0.81411	0.71329	I.4019	I.2283	I.7220	30
31	.58094	.81395	.71373	.4011	.2286	.7213	29
32	.58118	.81378	.71417	.4002	.2288	.7206	28
33	.58141	.81361	.71461	.3994	.2291	.7199	27
34	.58165	.81344	.71505	.3985	.2293	.7192	26
35	0.58189	0.81327	0.71549	I.3976	I.2296	I.7185	25
36	.58212	.81310	.71593	.3968	.2298	.7178	24
37	.58236	.81293	.71637	.3959	.2301	.7171	23
38	.58259	.81276	.71681	.3951	.2304	.7164	22
39	.58283	.81259	.71725	.3942	.2306	.7157	21
40	0.58307	0.81242	0.71769	I.3933	I.2309	I.7151	20
41	.58330	.81225	.71813	.3925	.2311	.7144	19
42	.58354	.81208	.71857	.3916	.2314	.7137	18
43	.58378	.81191	.71901	.3908	.2316	.7130	17
44	.58401	.81174	.71945	.3899	.2319	.7123	16
45	0.58425	0.81157	0.71990	I.3891	I.2322	I.7116	15
46	.58448	.81140	.72034	.3882	.2324	.7109	14
47	.58472	.81123	.72078	.3874	.2327	.7102	13
48	.58496	.81106	.72122	.3865	.2329	.7095	12
49	.58519	.81089	.72166	.3857	.2332	.7088	11
50	0.58543	0.81072	0.72211	I.3848	I.2335	I.7081	10
51	.58566	.81055	.72255	.3840	.2337	.7075	9
52	.58590	.81038	.72299	.3831	.2340	.7068	8
53	.58614	.81021	.72344	.3823	.2342	.7061	7
54	.58637	.81004	.72388	.3814	.2345	.7054	6
55	0.58661	0.80987	0.72432	I.3806	I.2348	I.7047	5
56	.58684	.80970	.72477	.3797	.2350	.7040	4
57	.58708	.80953	.72521	.3789	.2353	.7033	3
58	.58731	.80936	.72565	.3781	.2355	.7027	2
59	.58755	.80919	.72610	.3772	.2358	.7020	1
60	0.58778	0.80902	0.72654	I.3764	I.2361	I.7013	0
M	Cosine	Sine	Cotan.	Tan.	Cosec.	Secant	M

M	Sine	Cosine	Tan.	Cotan.	Secant	Cosec.	M
0	0.58778	0.80902	0.72654	I.3764	I.2361	I.7013	60
1	.58802	.80885	.72699	.3755	.2363	.7006	59
2	.58825	.80867	.72743	.3747	.2366	.6999	58
3	.58849	.80850	.72788	.3738	.2368	.6993	57
4	.58873	.80833	.72832	.3730	.2371	.6986	56
5	0.58896	0.80816	0.72877	I.3722	I.2374	I.6979	55
6	.58920	.80799	.72921	.3713	.2376	.6972	54
7	.58943	.80782	.72966	.3705	.2379	.6965	53
8	.58967	.80765	.73010	.3697	.2382	.6959	52
9	.58990	.80747	.73055	.3688	.2384	.6952	51
10	0.59014	0.80730	0.73100	I.3680	I.2387	I.6945	50
11	.59037	.80713	.73144	.3672	.2389	.6938	49
12	.59060	.80696	.73189	.3663	.2392	.6932	48
13	.59084	.80679	.73234	.3655	.2395	.6925	47
14	.59107	.80662	.73278	.3647	.2397	.6918	46
15	0.59131	0.80644	0.73323	I.3638	I.2400	I.6912	45
16	.59154	.80627	.73368	.3630	.2403	.6905	44
17	.59178	.80610	.73412	.3622	.2405	.6898	43
18	.59201	.80593	.73457	.3613	.2408	.6891	42
19	.59225	.80576	.73502	.3605	.2411	.6885	41
20	0.59248	0.80558	0.73547	I.3597	I.2413	I.6878	40
21	.59272	.80541	.73592	.3588	.2416	.6871	39
22	.59295	.80524	.73637	.3580	.2419	.6865	38
23	.59318	.80507	.73681	.3572	.2421	.6858	37
24	.59342	.80489	.73726	.3564	.2424	.6851	36
25	0.59365	0.80472	0.73771	I.3555	I.2427	I.6845	35
26	.59389	.80455	.73816	.3547	.2429	.6838	34
27	.59412	.80437	.73861	.3539	.2432	.6831	33
28	.59435	.80420	.73906	.3531	.2435	.6825	32
29	.59459	.80403	.73951	.3522	.2437	.6818	31
30	0.59482	0.80386	0.73996	I.3514	I.2440	I.6812	30
31	.59506	.80368	.74041	.3506	.2443	.6805	29
32	.59529	.80351	.74086	.3498	.2445	.6798	28
33	.59552	.80334	.74131	.3489	.2448	.6792	27
34	.59576	.80316	.74176	.3481	.2451	.6785	26
35	0.59599	0.80299	0.74221	I.3473	I.2453	I.6779	25
36	.59622	.80282	.74266	.3465	.2456	.6772	24
37	.59646	.80264	.74312	.3457	.2459	.6766	23
38	.59669	.80247	.74357	.3449	.2461	.6759	22
39	.59692	.80230	.74402	.3440	.2464	.6752	21
40	0.59716	0.80212	0.74447	I.3432	I.2467	I.6746	20
41	.59739	.80195	.74492	.3424	.2470	.6739	19
42	.59762	.80177	.74538	.3416	.2472	.6733	18
43	.59786	.80160	.74583	.3408	.2475	.6726	17
44	.59809	.80143	.74628	.3400	.2478	.6720	16
45	0.59832	0.80125	0.74673	I.3392	I.2480	I.6713	15
46	.59856	.80108	.74719	.3383	.2483	.6707	14
47	.59879	.80090	.74764	.3375	.2486	.6700	13
48	.59902	.80073	.74809	.3367	.2488	.6694	12
49	.59926	.80056	.74855	.3359	.2491	.6687	11
50	0.59949	0.80038	0.74900	I.3351	I.2494	I.6681	10
51	.59972	.80021	.74946	.3343	.2497	.6674	9
52	.59995	.80003	.74991	.3335	.2499	.6668	8
53	.60019	.79986	.75037	.3327	.2502	.6661	7
54	.60042	.79968	.75082	.3319	.2505	.6655	6
55	0.60065	0.79951	0.75128	I.3311	I.2508	I.6648	5
56	.60088	.79933	.75173	.3303	.2510	.6642	4
57	.60112	.79916	.75219	.3294	.2513	.6636	3
58	.60135	.79898	.75264	.3286	.2516	.6629	2
59	.60158	.79881	.75310	.3278	.2519	.6623	1
60	0.60181	0.79863	0.75355	I.3270	I.2521	I.6616	0
M	Cosine	Sine	Cotan.	Tan.	Cosec.	Secant	M



# 37° Natural Trigonometric Functions

M	Sine	Cosine	Tan.	Cotan.	Secant	Cosec.	M
0	0.60181	0.79863	0.75355	I. 3270	I. 2521	I. 6616	60
1	.60205	.79846	.75401	.3262	.2524	.6610	59
2	.60228	.79828	.75447	.3254	.2527	.6603	58
3	.60251	.79811	.75492	.3246	.2530	.6597	57
4	.60274	.79793	.75538	.3238	.2532	.6591	56
5	0.60298	0.79776	0.75584	I. 3230	I. 2535	I. 6584	55
6	.60320	.79758	.75629	.3222	.2538	.6578	54
7	.60344	.79741	.75675	.3214	.2541	.6572	53
8	.60367	.79723	.75721	.3206	.2543	.6565	52
9	.60390	.79706	.75767	.3198	.2546	.6559	51
10	0.60413	0.79688	0.75812	I. 3190	I. 2549	I. 6552	50
11	.60437	.79670	.75858	.3182	.2552	.6546	49
12	.60460	.79653	.75904	.3174	.2554	.6540	48
13	.60483	.79635	.75950	.3166	.2557	.6533	47
14	.60506	.79618	.75996	.3159	.2560	.6527	46
15	0.60529	0.79600	0.76042	I. 3151	I. 2563	I. 6521	45
16	.60552	.79582	.76088	.3143	.2565	.6514	44
17	.60576	.79565	.76134	.3135	.2568	.6508	43
18	.60599	.79547	.76179	.3127	.2571	.6502	42
19	.60622	.79530	.76225	.3119	.2574	.6496	41
20	0.60645	0.79512	0.76271	I. 3111	I. 2577	I. 6489	40
21	.60668	.79494	.76317	.3103	.2579	.6483	39
22	.60691	.79477	.76364	.3095	.2582	.6477	38
23	.60714	.79459	.76410	.3087	.2585	.6470	37
24	.60737	.79441	.76456	.3079	.2588	.6464	36
25	0.60761	0.79424	0.76502	I. 3071	I. 2591	I. 6458	35
26	.60784	.79406	.76548	.3064	.2593	.6452	34
27	.60807	.79388	.76594	.3056	.2596	.6445	33
28	.60830	.79371	.76640	.3048	.2599	.6439	32
29	.60853	.79353	.76686	.3040	.2602	.6433	31
30	0.60876	0.79335	0.76733	I. 3032	I. 2605	I. 6427	30
31	.60899	.79318	.76779	.3024	.2607	.6420	29
32	.60922	.79300	.76825	.3016	.2610	.6414	28
33	.60945	.79282	.76871	.3009	.2613	.6408	27
34	.60968	.79264	.76918	.3001	.2616	.6402	26
35	0.60991	0.79247	0.76964	I. 2993	I. 2619	I. 6396	25
36	.61014	.79229	.77010	.2985	.2622	.6389	24
37	.61037	.79211	.77057	.2977	.2624	.6383	23
38	.61061	.79193	.77103	.2970	.2627	.6377	22
39	.61084	.79176	.77149	.2962	.2630	.6371	21
40	0.61107	0.79158	0.77196	I. 2954	I. 2633	I. 6365	20
41	.61130	.79140	.77242	.2946	.2636	.6359	19
42	.61153	.79122	.77289	.2938	.2639	.6352	18
43	.61176	.79104	.77335	.2931	.2641	.6346	17
44	.61199	.79087	.77382	.2923	.2644	.6340	16
45	0.61222	0.79069	0.77428	I. 2915	I. 2647	I. 6334	15
46	.61245	.79051	.77475	.2907	.2650	.6328	14
47	.61268	.79033	.77521	.2900	.2653	.6322	13
48	.61290	.79015	.77568	.2892	.2656	.6316	12
49	.61314	.78998	.77614	.2884	.2659	.6309	11
50	0.61337	0.78980	0.77661	I. 2876	I. 2661	I. 6303	10
51	.61360	.78962	.77708	.2869	.2664	.6297	9
52	.61383	.78944	.77754	.2861	.2667	.6291	8
53	.61405	.78926	.77801	.2853	.2670	.6285	7
54	.61428	.78908	.77848	.2845	.2673	.6279	6
55	0.61451	0.78890	0.77895	I. 2838	I. 2676	I. 6273	5
56	.61474	.78873	.77941	.2830	.2679	.6267	4
57	.61497	.78855	.77988	.2822	.2681	.6261	3
58	.61520	.78837	.78035	.2815	.2684	.6255	2
59	.61543	.78819	.78082	.2807	.2687	.6249	1
60	0.61566	0.78801	0.78128	I. 2799	I. 2690	I. 6243	0
M	Cosine	Sine	Cotan.	Tan.	Cosec.	Secant	M

# 38° Natural Trigonometric Functions

M	Sine	Cosine	Tan.	Cotan.	Secant	Cosec.	M
0	0.61566	0.78801	0.78128	1.2799	1.2690	1.6243	60
1	.61589	.78783	.78175	.2792	.2693	.6237	59
2	.61612	.78765	.78222	.2784	.2696	.6231	58
3	.61635	.78747	.78269	.2776	.2699	.6224	57
4	.61658	.78729	.78316	.2769	.2702	.6218	56
5	0.61681	0.78711	0.78363	1.2761	1.2705	1.6212	55
6	.61703	.78693	.78410	.2753	.2707	.6206	54
7	.61726	.78675	.78457	.2746	.2710	.6200	53
8	.61749	.78657	.78504	.2738	.2713	.6194	52
9	.61772	.78640	.78551	.2730	.2716	.6188	51
10	0.61795	0.78622	0.78598	1.2723	1.2719	1.6182	50
11	.61818	.78604	.78645	.2715	.2722	.6176	49
12	.61841	.78586	.78692	.2708	.2725	.6170	48
13	.61864	.78568	.78739	.2700	.2728	.6164	47
14	.61886	.78550	.78786	.2692	.2731	.6159	46
15	0.61909	0.78532	0.78834	1.2685	1.2734	1.6153	45
16	.61932	.78514	.78881	.2677	.2737	.6147	44
17	.61955	.78496	.78928	.2670	.2739	.6141	43
18	.61978	.78478	.78975	.2662	.2742	.6135	42
19	.62001	.78460	.79022	.2655	.2745	.6129	41
20	0.62023	0.78441	0.79070	1.2647	1.2748	1.6123	40
21	.62046	.78423	.79117	.2639	.2751	.6117	39
22	.62069	.78405	.79164	.2632	.2754	.6111	38
23	.62092	.78387	.79212	.2624	.2757	.6105	37
24	.62115	.78369	.79259	.2617	.2760	.6099	36
25	0.62137	0.78351	0.79306	1.2609	1.2763	1.6093	35
26	.62160	.78333	.79354	.2602	.2766	.6087	34
27	.62183	.78315	.79401	.2594	.2769	.6081	33
28	.62206	.78297	.79449	.2587	.2772	.6077	32
29	.62229	.78279	.79496	.2579	.2775	.6070	31
30	0.62251	0.78261	0.79543	1.2572	1.2778	1.6064	30
31	.62274	.78243	.79591	.2564	.2781	.6058	29
32	.62297	.78224	.79639	.2557	.2784	.6052	28
33	.62320	.78206	.79686	.2549	.2787	.6046	27
34	.62342	.78188	.79734	.2542	.2790	.6040	26
35	0.62365	0.78170	0.79781	1.2534	1.2793	1.6034	25
36	.62388	.78152	.79829	.2527	.2795	.6029	24
37	.62411	.78134	.79876	.2519	.2798	.6023	23
38	.62433	.78116	.79924	.2512	.2801	.6017	22
39	.62456	.78097	.79972	.2504	.2804	.6011	21
40	0.62479	0.78079	0.80020	1.2497	1.2807	1.6005	20
41	.62501	.78061	.80067	.2489	.2810	.6000	19
42	.62524	.78043	.80115	.2482	.2813	.5994	18
43	.62547	.78025	.80163	.2475	.2816	.5988	17
44	.62570	.78007	.80211	.2467	.2819	.5982	16
45	0.62592	0.77988	0.80258	1.2460	1.2822	1.5976	15
46	.62615	.77970	.80306	.2452	.2825	.5971	14
47	.62638	.77952	.80354	.2445	.2828	.5965	13
48	.62660	.77934	.80402	.2437	.2831	.5959	12
49	.62683	.77915	.80450	.2430	.2834	.5953	11
50	0.62706	0.77897	0.80498	1.2423	1.2837	1.5947	10
51	.62728	.77879	.80546	.2415	.2840	.5942	9
52	.62751	.77861	.80594	.2408	.2843	.5936	8
53	.62774	.77842	.80642	.2400	.2846	.5930	7
54	.62796	.77824	.80690	.2393	.2849	.5924	6
55	0.62819	0.77806	0.80738	1.2386	1.2852	1.5919	5
56	.62841	.77788	.80786	.2378	.2855	.5913	4
57	.62864	.77769	.80834	.2371	.2858	.5907	3
58	.62887	.77751	.80882	.2364	.2861	.5901	2
59	.62909	.77733	.80930	.2356	.2864	.5896	1
60	0.62932	0.77715	0.80978	1.2349	1.2867	1.5890	0
M	Cosine	Sine	Cotan.	Tan.	Cosec.	Secant	M

M	Sine	Cosine	Tan.	Cotan.	Secant	Cosec.	M
0	0.62932	0.77715	0.80978	1.2349	1.2867	1.5890	60
1	.62955	.77696	.81026	.2342	.2871	.5884	59
2	.62977	.77678	.81075	.2334	.2874	.5879	58
3	.63000	.77660	.81123	.2327	.2877	.5873	57
4	.63022	.77641	.81171	.2320	.2880	.5867	56
5	0.63045	0.77623	0.81219	1.2312	1.2883	1.5862	55
6	.63067	.77605	.81268	.2305	.2886	.5856	54
7	.63090	.77586	.81316	.2297	.2889	.5850	53
8	.63113	.77568	.81364	.2290	.2892	.5845	52
9	.63135	.77549	.81413	.2283	.2895	.5839	51
10	0.63158	0.77531	0.81461	1.2276	1.2898	1.5833	50
11	.63180	.77513	.81509	.2268	.2901	.5828	49
12	.63203	.77494	.81558	.2261	.2904	.5822	48
13	.63225	.77476	.81606	.2254	.2907	.5816	47
14	.63248	.77458	.81655	.2247	.2910	.5811	46
15	0.63270	0.77439	0.81703	1.2239	1.2913	1.5805	45
16	.63293	.77421	.81752	.2232	.2916	.5799	44
17	.63315	.77402	.81800	.2225	.2919	.5794	43
18	.63338	.77384	.81849	.2218	.2922	.5788	42
19	.63360	.77365	.81898	.2210	.2926	.5783	41
20	0.63383	0.77347	0.81946	1.2203	1.2929	1.5777	40
21	.63405	.77329	.81995	.2196	.2932	.5771	39
22	.63428	.77310	.82043	.2189	.2935	.5766	38
23	.63450	.77292	.82092	.2181	.2938	.5760	37
24	.63473	.77273	.82141	.2174	.2941	.5755	36
25	0.63495	0.77255	0.82190	1.2167	1.2944	1.5749	35
26	.63518	.77236	.82238	.2160	.2947	.5743	34
27	.63540	.77218	.82287	.2152	.2950	.5738	33
28	.63563	.77199	.82336	.2145	.2953	.5732	32
29	.63585	.77181	.82385	.2138	.2956	.5727	31
30	0.63608	0.77162	0.82434	1.2131	1.2960	1.5721	30
31	.63630	.77144	.82482	.2124	.2963	.5716	29
32	.63653	.77125	.82531	.2117	.2966	.5710	28
33	.63675	.77107	.82580	.2109	.2969	.5705	27
34	.63697	.77088	.82629	.2102	.2972	.5699	26
35	0.63720	0.77070	0.82678	1.2095	1.2975	1.5694	25
36	.63742	.77051	.82727	.2088	.2978	.5688	24
37	.63765	.77033	.82776	.2081	.2981	.5683	23
38	.63787	.77014	.82825	.2074	.2985	.5677	22
39	.63810	.76996	.82874	.2066	.2988	.5672	21
40	0.63832	0.76977	0.82923	1.2059	1.2991	1.5666	20
41	.63854	.76958	.82972	.2052	.2994	.5661	19
42	.63877	.76940	.83022	.2045	.2997	.5655	18
43	.63899	.76921	.83071	.2038	.3000	.5650	17
44	.63921	.76903	.83120	.2031	.3003	.5644	16
45	0.63944	0.76884	0.83169	1.2024	1.3006	1.5639	15
46	.63966	.76865	.83218	.2016	.3010	.5633	14
47	.63989	.76847	.83267	.2009	.3013	.5628	13
48	.64011	.76828	.83317	.2002	.3016	.5622	12
49	.64033	.76810	.83366	.1995	.3019	.5617	11
50	0.64056	0.76791	0.83415	1.1988	1.3022	1.5611	10
51	.64078	.76772	.83465	.1981	.3025	.5606	9
52	.64100	.76754	.83514	.1974	.3029	.5600	8
53	.64123	.76735	.83563	.1967	.3032	.5595	7
54	.64145	.76716	.83613	.1960	.3035	.5590	6
55	0.64167	0.76698	0.83662	1.1953	1.3038	1.5584	5
56	.64189	.76679	.83712	.1946	.3041	.5579	4
57	.64212	.76660	.83761	.1939	.3044	.5573	3
58	.64234	.76642	.83811	.1932	.3048	.5568	2
59	.64256	.76623	.83860	.1924	.3051	.5563	1
60	0.64279	0.76604	0.83910	1.1917	1.3054	1.5557	0
M	Cosine	Sine	Cotan.	Tan.	Cosec.	Secant	M

**40° Natural Trigonometric Functions**

M	Sine	Cosine	Tan.	Cotan.	Secant	Cosec.	M
0	0.64279	0.76604	0.83910	1.1917	1.3054	1.5557	60
1	.64301	.76586	.83959	.1910	.3057	.5552	59
2	.64323	.76567	.84009	.1903	.3060	.5546	58
3	.64345	.76548	.84059	.1896	.3064	.5541	57
4	.64368	.76530	.84108	.1889	.3067	.5536	56
5	0.64390	0.76511	0.84158	1.1882	1.3070	1.5530	55
6	.64412	.76492	.84208	.1875	.3073	.5525	54
7	.64435	.76473	.84257	.1868	.3076	.5520	53
8	.64457	.76455	.84307	.1861	.3080	.5514	52
9	.64479	.76436	.84357	.1854	.3083	.5509	51
10	0.64501	0.76417	0.84407	1.1847	1.3086	1.5503	50
11	.64523	.76398	.84457	.1840	.3089	.5498	49
12	.64546	.76380	.84506	.1833	.3092	.5493	48
13	.64568	.76361	.84556	.1826	.3096	.5487	47
14	.64590	.76342	.84606	.1819	.3099	.5482	46
15	0.64612	0.76323	0.84656	1.1812	1.3102	1.5477	45
16	.64635	.76304	.84706	.1805	.3105	.5471	44
17	.64657	.76286	.84756	.1798	.3109	.5466	43
18	.64679	.76267	.84806	.1791	.3112	.5461	42
19	.64701	.76248	.84856	.1785	.3115	.5456	41
20	0.64723	0.76229	0.84906	1.1778	1.3118	1.5450	40
21	.64745	.76210	.84956	.1771	.3121	.5445	39
22	.64768	.76191	.85006	.1764	.3125	.5440	38
23	.64790	.76173	.85056	.1757	.3128	.5434	37
24	.64812	.76154	.85107	.1750	.3131	.5429	36
25	0.64834	0.76135	0.85157	1.1743	1.3134	1.5424	35
26	.64856	.76116	.85207	.1736	.3138	.5419	34
27	.64878	.76097	.85257	.1729	.3141	.5413	33
28	.64900	.76078	.85307	.1722	.3144	.5408	32
29	.64923	.76059	.85358	.1715	.3148	.5403	31
30	0.64945	0.76041	0.85408	1.1708	1.3151	1.5398	30
31	.64967	.76022	.85458	.1702	.3154	.5392	29
32	.64989	.76003	.85509	.1695	.3157	.5387	28
33	.65011	.75984	.85559	.1688	.3161	.5382	27
34	.65033	.75965	.85609	.1681	.3164	.5377	26
35	0.65055	0.75946	0.85660	1.1674	1.3167	1.5371	25
36	.65077	.75927	.85710	.1667	.3170	.5366	24
37	.65100	.75908	.85761	.1660	.3174	.5361	23
38	.65121	.75889	.85811	.1653	.3177	.5356	22
39	.65144	.75870	.85862	.1647	.3180	.5351	21
40	0.65166	0.75851	0.85912	1.1640	1.3184	1.5345	20
41	.65188	.75832	.85963	.1633	.3187	.5340	19
42	.65210	.75813	.86013	.1626	.3190	.5335	18
43	.65232	.75794	.86064	.1619	.3193	.5330	17
44	.65254	.75775	.86115	.1612	.3197	.5325	16
45	0.65276	0.75756	0.86165	1.1605	1.3200	1.5319	15
46	.65298	.75737	.86216	.1599	.3203	.5314	14
47	.65320	.75718	.86267	.1592	.3207	.5309	13
48	.65342	.75700	.86318	.1585	.3210	.5304	12
49	.65364	.75680	.86368	.1578	.3213	.5299	11
50	0.65386	0.75661	0.86419	1.1571	1.3217	1.5294	10
51	.65408	.75642	.86470	.1565	.3220	.5289	9
52	.65430	.75623	.86521	.1558	.3223	.5283	8
53	.65452	.75604	.86572	.1551	.3227	.5278	7
54	.65474	.75585	.86623	.1544	.3230	.5273	6
55	0.65496	0.75566	0.86674	1.1537	1.3233	1.5268	5
56	.65518	.75547	.86725	.1531	.3237	.5263	4
57	.65540	.75528	.86775	.1524	.3240	.5258	3
58	.65562	.75509	.86826	.1517	.3243	.5253	2
59	.65584	.75490	.86878	.1510	.3247	.5248	1
60	0.65606	0.75471	0.86929	1.1504	1.3250	1.5242	0
M	Cosine	Sine	Cotan.	Tan.	Cosec.	Secant	M

# 41° Natural Trigonometric Functions

M	Sine	Cosine	Tan.	Cotan.	Secant	Cosec.	M
0	0.65606	0.75471	0.86929	I.1504	I.3250	I.5242	60
1	.65628	.75452	.86980	.I497	.3253	.5237	59
2	.65650	.75433	.87031	.I490	.3257	.5232	58
3	.65672	.75414	.87082	.I483	.3260	.5227	57
4	.65694	.75394	.87133	.I477	.3263	.5222	56
5	0.65716	0.75375	0.87184	I.1470	I.3267	I.5217	55
6	.65737	.75356	.87235	.I463	.3270	.5212	54
7	.65759	.75337	.87287	.I456	.3274	.5207	53
8	.65781	.75318	.87338	.I450	.3277	.5202	52
9	.65803	.75299	.87389	.I443	.3280	.5197	51
10	0.65825	0.75280	0.87441	I.1436	I.3284	I.5192	50
11	.65847	.75261	.87492	.I430	.3287	.5187	49
12	.65869	.75241	.87543	.I423	.3290	.5182	48
13	.65891	.75222	.87595	.I416	.3294	.5177	47
14	.65913	.75203	.87646	.I409	.3297	.5171	46
15	0.65934	0.75184	0.87698	I.1403	I.3301	I.5166	45
16	.65956	.75165	.87749	.I396	.3304	.5161	44
17	.65978	.75146	.87801	.I389	.3307	.5156	43
18	.66000	.75126	.87852	.I383	.3311	.5151	42
19	.66022	.75107	.87904	.I376	.3314	.5146	41
20	0.66044	0.75088	0.87955	I.1369	I.3318	I.5141	40
21	.66066	.75069	.88007	.I363	.3321	.5136	39
22	.66087	.75049	.88058	.I356	.3324	.5131	38
23	.66109	.75030	.88110	.I349	.3328	.5126	37
24	.66131	.75011	.88162	.I343	.3331	.5121	36
25	0.66153	0.74992	0.88213	I.1336	I.3335	I.5116	35
26	.66175	.74973	.88265	.I329	.3338	.5111	34
27	.66197	.74953	.88317	.I323	.3342	.5106	33
28	.66218	.74934	.88369	.I316	.3345	.5101	32
29	.66240	.74915	.88421	.I309	.3348	.5096	31
30	0.66262	0.74895	0.88472	I.1303	I.3352	I.5092	30
31	.66284	.74876	.88524	.I296	.3355	.5087	29
32	.66305	.74857	.88576	.I290	.3359	.5082	28
33	.66327	.74838	.88628	.I283	.3362	.5077	27
34	.66349	.74818	.88680	.I276	.3366	.5072	26
35	0.66371	0.74799	0.88732	I.1270	I.3369	I.5067	25
36	.66393	.74780	.88784	.I263	.3372	.5062	24
37	.66414	.74760	.88836	.I257	.3376	.5057	23
38	.66436	.74741	.88888	.I250	.3379	.5052	22
39	.66458	.74722	.88940	.I243	.3383	.5047	21
40	0.66479	0.74702	0.88992	I.1237	I.3386	I.5042	20
41	.66501	.74683	.89044	.I230	.3390	.5037	19
42	.66523	.74664	.89097	.I224	.3393	.5032	18
43	.66545	.74644	.89149	.I217	.3397	.5027	17
44	.66566	.74625	.89201	.I211	.3400	.5022	16
45	0.66588	0.74606	0.89253	I.1204	I.3404	I.5018	15
46	.66610	.74586	.89306	.I197	.3407	.5013	14
47	.66631	.74567	.89358	.I191	.3411	.5008	13
48	.66653	.74548	.89410	.I184	.3414	.5003	12
49	.66675	.74528	.89463	.I178	.3418	.4998	11
50	0.66697	0.74509	0.89515	I.1171	I.3421	I.4993	10
51	.66718	.74489	.89567	.I165	.3425	.4988	9
52	.66740	.74470	.89620	.I158	.3428	.4983	8
53	.66762	.74450	.89672	.I152	.3432	.4979	7
54	.66783	.74431	.89725	.I145	.3435	.4974	6
55	0.66805	0.74412	0.89777	I.1139	I.3439	I.4969	5
56	.66826	.74392	.89830	.I132	.3442	.4964	4
57	.66848	.74373	.89882	.I126	.3446	.4959	3
58	.66870	.74353	.89935	.I119	.3449	.4954	2
59	.66891	.74334	.89988	.I113	.3453	.4949	1
60	0.66913	0.74314	0.90040	I.1106	I.3456	I.4945	0
<b>M</b>	<b>Cosine</b>	<b>Sine</b>	<b>Cotan.</b>	<b>Tan.</b>	<b>Cosec.</b>	<b>Secant</b>	<b>M</b>

42° Natural Trigonometric Functions

M	Sine	Cosine	Tan.	Cotan.	Secant	Cosec.	M
0	0.66913	0.74314	0.90040	I.1106	I.3456	I.4945	60
1	.66935	.74295	.90093	.1100	.3460	.4940	59
2	.66956	.74275	.90146	.1093	.3463	.4935	58
3	.66978	.74256	.90198	.1086	.3467	.4930	57
4	.66999	.74236	.90251	.1080	.3470	.4925	56
5	0.67021	0.74217	0.90304	I.1074	I.3474	I.4921	55
6	.67043	.74197	.90357	.1067	.3477	.4916	54
7	.67064	.74178	.90410	.1061	.3481	.4911	53
8	.67086	.74158	.90463	.1054	.3485	.4906	52
9	.67107	.74139	.90515	.1048	.3488	.4901	51
10	0.67129	0.74119	0.90568	I.1041	I.3492	I.4897	50
11	.67150	.74100	.90621	.1035	.3495	.4892	49
12	.67172	.74080	.90674	.1028	.3499	.4887	48
13	.67194	.74061	.90727	.1022	.3502	.4882	47
14	.67215	.74041	.90780	.1015	.3506	.4877	46
15	0.67237	0.74022	0.90834	I.1009	I.3509	I.4873	45
16	.67258	.74002	.90887	.1003	.3513	.4868	44
17	.67280	.73983	.90940	.0996	.3517	.4863	43
18	.67301	.73963	.90993	.0990	.3520	.4858	42
19	.67323	.73943	.91046	.0983	.3524	.4854	41
20	0.67344	0.73924	0.91099	I.0977	I.3527	I.4849	40
21	.67366	.73904	.91153	.0971	.3531	.4844	39
22	.67387	.73885	.91206	.0964	.3534	.4839	38
23	.67409	.73865	.91259	.0958	.3538	.4835	37
24	.67430	.73845	.91312	.0951	.3542	.4830	36
25	0.67452	0.73826	0.91366	I.0945	I.3545	I.4825	35
26	.67473	.73806	.91419	.0939	.3549	.4821	34
27	.67495	.73787	.91473	.0932	.3552	.4816	33
28	.67516	.73767	.91526	.0926	.3556	.4811	32
29	.67537	.73747	.91580	.0919	.3560	.4806	31
30	0.67559	0.73728	0.91633	I.0913	I.3563	I.4802	30
31	.67580	.73708	.91687	.0907	.3567	.4797	29
32	.67602	.73688	.91740	.0900	.3571	.4792	28
33	.67623	.73669	.91794	.0894	.3574	.4788	27
34	.67645	.73649	.91847	.0888	.3578	.4783	26
35	0.67666	0.73629	0.91901	I.0881	I.3581	I.4778	25
36	.67688	.73610	.91955	.0875	.3585	.4774	24
37	.67709	.73590	.92008	.0868	.3589	.4769	23
38	.67730	.73570	.92062	.0862	.3592	.4764	22
39	.67752	.73551	.92116	.0856	.3596	.4760	21
40	0.67773	0.73531	0.92170	I.0849	I.3600	I.4755	20
41	.67794	.73511	.92223	.0843	.3603	.4750	19
42	.67816	.73491	.92277	.0837	.3607	.4746	18
43	.67837	.73472	.92331	.0830	.3611	.4741	17
44	.67859	.73452	.92385	.0824	.3614	.4736	16
45	0.67880	0.73432	0.92439	I.0818	I.3618	I.4732	15
46	.67901	.73412	.92493	.0812	.3622	.4727	14
47	.67923	.73393	.92547	.0805	.3625	.4723	13
48	.67944	.73373	.92601	.0799	.3629	.4718	12
49	.67965	.73353	.92655	.0793	.3633	.4713	11
50	0.67987	0.73333	0.92709	I.0786	I.3636	I.4709	10
51	.68008	.73314	.92763	.0780	.3640	.4704	9
52	.68029	.73294	.92817	.0774	.3644	.4699	8
53	.68051	.73274	.92871	.0767	.3647	.4695	7
54	.68072	.73254	.92926	.0761	.3651	.4690	6
55	0.68093	0.73234	0.92980	I.0755	I.3655	I.4686	5
56	.68115	.73215	.93034	.0749	.3658	.4681	4
57	.68136	.73195	.93088	.0742	.3662	.4676	3
58	.68157	.73175	.93143	.0736	.3666	.4672	2
59	.68178	.73155	.93197	.0730	.3669	.4667	1
60	0.68200	0.73135	0.93251	I.0724	I.3673	I.4663	0
M	Cosine	Sine	Cotan.	Tan.	Cosec.	Secant	M

# 43° Natural Trigonometric Functions

M	Sine	Cosine	Tan.	Cotan.	Secant	Cosec.	M
0	0.68200	0.73135	0.93251	I.0724	I.3673	I.4663	60
1	.68221	.73115	.93306	.0717	.3677	.4658	59
2	.68242	.73096	.93360	.0711	.3681	.4654	58
3	.68264	.73076	.93415	.0705	.3684	.4649	57
4	.68285	.73056	.93469	.0699	.3688	.4644	56
5	0.68306	0.73036	0.93524	I.0692	I.3692	I.4640	55
6	.68327	.73016	.93578	.0686	.3695	.4635	54
7	.68349	.72996	.93633	.0680	.3699	.4631	53
8	.68370	.72976	.93687	.0674	.3703	.4626	52
9	.68391	.72956	.93742	.0667	.3707	.4622	51
10	0.68412	0.72937	0.93797	I.0661	I.3710	I.4617	50
11	.68433	.72917	.93851	.0655	.3714	.4613	49
12	.68455	.72897	.93906	.0649	.3718	.4608	48
13	.68476	.72877	.93961	.0643	.3722	.4604	47
14	.68497	.72857	.94016	.0636	.3725	.4599	46
15	0.68518	0.72837	0.94071	I.0630	I.3729	I.4595	45
16	.68539	.72817	.94125	.0624	.3733	.4590	44
17	.68561	.72797	.94180	.0618	.3737	.4586	43
18	.68582	.72777	.94235	.0612	.3740	.4581	42
19	.68603	.72757	.94290	.0605	.3744	.4577	41
20	0.68624	0.72737	0.94345	I.0599	I.3748	I.4572	40
21	.68645	.72717	.94400	.0593	.3752	.4568	39
22	.68666	.72697	.94455	.0587	.3756	.4563	38
23	.68688	.72677	.94510	.0581	.3759	.4559	37
24	.68709	.72657	.94565	.0575	.3763	.4554	36
25	0.68730	0.72637	0.94620	I.0568	I.3767	I.4550	35
26	.68751	.72617	.94675	.0562	.3771	.4545	34
27	.68772	.72597	.94731	.0556	.3774	.4541	33
28	.68793	.72577	.94786	.0550	.3778	.4536	32
29	.68814	.72557	.94841	.0544	.3782	.4532	31
30	0.68835	0.72537	0.94896	I.0538	I.3786	I.4527	30
31	.68856	.72517	.94952	.0532	.3790	.4523	29
32	.68878	.72497	.95007	.0525	.3794	.4518	28
33	.68899	.72477	.95062	.0519	.3797	.4514	27
34	.68920	.72457	.95118	.0513	.3801	.4510	26
35	0.68941	0.72437	0.95173	I.0507	I.3805	I.4505	25
36	.68962	.72417	.95229	.0501	.3809	.4501	24
37	.68983	.72397	.95284	.0495	.3813	.4496	23
38	.69004	.72377	.95340	.0489	.3816	.4492	22
39	.69025	.72357	.95395	.0483	.3820	.4487	21
40	0.69046	0.72337	0.95451	I.0476	I.3824	I.4483	20
41	.69067	.72317	.95506	.0470	.3828	.4479	19
42	.69088	.72297	.95562	.0464	.3832	.4474	18
43	.69109	.72277	.95618	.0458	.3836	.4470	17
44	.69130	.72256	.95673	.0452	.3839	.4465	16
45	0.69151	0.72236	0.95729	I.0446	I.3843	I.4461	15
46	.69172	.72216	.95785	.0440	.3847	.4457	14
47	.69193	.72196	.95841	.0434	.3851	.4452	13
48	.69214	.72176	.95896	.0428	.3855	.4448	12
49	.69235	.72156	.95952	.0422	.3859	.4443	11
50	0.69256	0.72136	0.96008	I.0416	I.3863	I.4439	10
51	.69277	.72115	.96064	.0410	.3867	.4435	9
52	.69298	.72095	.96120	.0404	.3870	.4430	8
53	.69319	.72075	.96176	.0397	.3874	.4426	7
54	.69340	.72055	.96232	.0391	.3878	.4422	6
55	0.69361	0.72035	0.96288	I.0385	I.3882	I.4417	5
56	.69382	.72015	.96344	.0379	.3886	.4413	4
57	.69403	.71994	.96400	.0373	.3890	.4408	3
58	.69424	.71974	.96456	.0367	.3894	.4404	2
59	.69445	.71954	.96513	.0361	.3898	.4400	1
60	0.69466	0.71934	0.96569	I.0355	I.3902	I.4395	0
M	Cosine	Sine	Cotan.	Tan.	Cosec.	Secant	M

# 44° Natural Trigonometric Functions

M	Sine	Cosine	Tan.	Cotan.	Secant	Cosec.	M
0	0.69466	0.71934	0.96569	I.0355	I.3902	I.4395	60
1	.69487	.71914	.96625	.0349	.3905	.4391	59
2	.69508	.71893	.96681	.0343	.3909	.4387	58
3	.69528	.71873	.96738	.0337	.3913	.4382	57
4	.69549	.71853	.96794	.0331	.3917	.4378	56
5	0.69570	0.71833	0.96850	I.0325	I.3921	I.4374	55
6	.69591	.71813	.96907	.0319	.3925	.4370	54
7	.69612	.71792	.96963	.0313	.3929	.4365	53
8	.69633	.71772	.97020	.0307	.3933	.4361	52
9	.69654	.71752	.97076	.0301	.3937	.4357	51
10	0.69675	0.71732	0.97133	I.0295	I.3941	I.4352	50
11	.69696	.71711	.97189	.0289	.3945	.4348	49
12	.69716	.71691	.97246	.0283	.3949	.4344	48
13	.69737	.71671	.97302	.0277	.3953	.4339	47
14	.69758	.71650	.97359	.0271	.3957	.4335	46
15	0.69779	0.71630	0.97416	I.0265	I.3960	I.4331	45
16	.69800	.71610	.97472	.0259	.3964	.4327	44
17	.69821	.71589	.97529	.0253	.3968	.4322	43
18	.69841	.71569	.97586	.0247	.3972	.4318	42
19	.69862	.71549	.97643	.0241	.3976	.4314	41
20	0.69883	0.71529	0.97700	I.0235	I.3980	I.4310	40
21	.69904	.71508	.97756	.0229	.3984	.4305	39
22	.69925	.71488	.97813	.0223	.3988	.4301	38
23	.69945	.71468	.97870	.0218	.3992	.4297	37
24	.69966	.71447	.97927	.0212	.3996	.4292	36
25	0.69987	0.71427	0.97984	I.0206	I.4000	I.4288	35
26	.70008	.71406	.98041	.0200	.4004	.4284	34
27	.70029	.71386	.98098	.0194	.4008	.4280	33
28	.70049	.71366	.98155	.0188	.4012	.4276	32
29	.70070	.71345	.98212	.0182	.4016	.4271	31
30	0.70091	0.71325	0.98270	I.0176	I.4020	I.4267	30
31	.70112	.71305	.98327	.0170	.4024	.4263	29
32	.70132	.71284	.98384	.0164	.4028	.4259	28
33	.70153	.71264	.98441	.0158	.4032	.4254	27
34	.70174	.71243	.98499	.0152	.4036	.4250	26
35	0.70194	0.71223	0.98556	I.0146	I.4040	I.4246	25
36	.70215	.71203	.98613	.0141	.4044	.4242	24
37	.70236	.71182	.98671	.0135	.4048	.4238	23
38	.70257	.71162	.98728	.0129	.4052	.4233	22
39	.70277	.71141	.98786	.0123	.4056	.4229	21
40	0.70298	0.71121	0.98843	I.0117	I.4060	I.4225	20
41	.70319	.71100	.98901	.0111	.4065	.4221	19
42	.70339	.71080	.98958	.0105	.4069	.4217	18
43	.70360	.71059	.99016	.0099	.4073	.4212	17
44	.70381	.71039	.99073	.0093	.4077	.4208	16
45	0.70401	0.71018	0.99131	I.0088	I.4081	I.4204	15
46	.70422	.70998	.99189	.0082	.4085	.4200	14
47	.70443	.70977	.99246	.0076	.4089	.4196	13
48	.70463	.70957	.99304	.0070	.4093	.4192	12
49	.70484	.70936	.99362	.0064	.4097	.4188	11
50	0.70505	0.70916	0.99420	I.0058	I.4101	I.4183	10
51	.70525	.70895	.99478	.0052	.4105	.4179	9
52	.70546	.70875	.99536	.0047	.4109	.4175	8
53	.70566	.70854	.99593	.0041	.4113	.4171	7
54	.70587	.70834	.99651	.0035	.4117	.4167	6
55	0.70608	0.70813	0.99709	I.0029	I.4122	I.4163	5
56	.70628	.70793	.99767	.0023	.4126	.4159	4
57	.70649	.70772	.99826	.0017	.4130	.4154	3
58	.70669	.70752	.99884	.0012	.4134	.4150	2
59	.70690	.70731	.99942	.0006	.4138	.4146	1
60	0.70711	0.70711	I.00000	I.0000	I.4142	I.4142	0
M	Cosine	Sine	Cotan.	Tan.	Cosec.	Secant	M



# NOTES

A grid of 12 columns and 20 rows for taking notes. The grid is composed of light gray lines forming a series of small squares. The word "NOTES" is centered at the top of the grid.





# DECIMAL EQUIVALENTS

	$\frac{1}{64}$	.015625
	$\frac{1}{32}$	.03125
	$\frac{3}{64}$	.046875
$\frac{1}{16}$		.0625
	$\frac{5}{64}$	.078125
	$\frac{3}{32}$	.09375
	$\frac{7}{64}$	.109375
$\frac{1}{8}$		.125
	$\frac{9}{64}$	.140625
	$\frac{5}{32}$	.15625
	$\frac{11}{64}$	.171875
$\frac{3}{16}$		.1875
	$\frac{13}{64}$	.203125
	$\frac{7}{32}$	.21875
	$\frac{15}{64}$	.234375
$\frac{1}{4}$		.25
	$\frac{17}{64}$	.265625
	$\frac{9}{32}$	.28125
	$\frac{19}{64}$	.296875
$\frac{5}{16}$		.3125
	$\frac{21}{64}$	.328125
	$\frac{11}{32}$	.34375
	$\frac{23}{64}$	.359375
$\frac{3}{8}$		.375
	$\frac{25}{64}$	.390625
	$\frac{13}{32}$	.40625
	$\frac{27}{64}$	.421875
$\frac{7}{16}$		.4375
	$\frac{29}{64}$	.453125
	$\frac{15}{32}$	.46875
	$\frac{31}{64}$	.48375
$\frac{1}{2}$		.5

	$\frac{33}{64}$	.515625
	$\frac{17}{32}$	.53125
	$\frac{35}{64}$	.546875
$\frac{9}{16}$		.5625
	$\frac{37}{64}$	.578125
	$\frac{19}{32}$	.59375
	$\frac{39}{64}$	.609375
$\frac{5}{8}$		.625
	$\frac{41}{64}$	.640625
	$\frac{21}{32}$	.65625
	$\frac{43}{64}$	.671875
$\frac{11}{16}$		.6875
	$\frac{45}{64}$	.703125
	$\frac{23}{32}$	.71875
	$\frac{47}{64}$	.734375
$\frac{3}{4}$		.75
	$\frac{49}{64}$	.765625
	$\frac{25}{32}$	.78125
	$\frac{51}{64}$	.796875
$\frac{13}{16}$		.8125
	$\frac{53}{64}$	.828125
	$\frac{27}{32}$	.84375
	$\frac{55}{64}$	.859375
$\frac{7}{8}$		.875
	$\frac{57}{64}$	.890625
	$\frac{29}{32}$	.90625
	$\frac{59}{64}$	.921875
$\frac{15}{16}$		.9375
	$\frac{61}{64}$	.953125
	$\frac{31}{32}$	.96875
	$\frac{63}{64}$	.984375
$\frac{1}{1}$		1.